

ST-S333ESG

SERVICE MANUAL

E Model

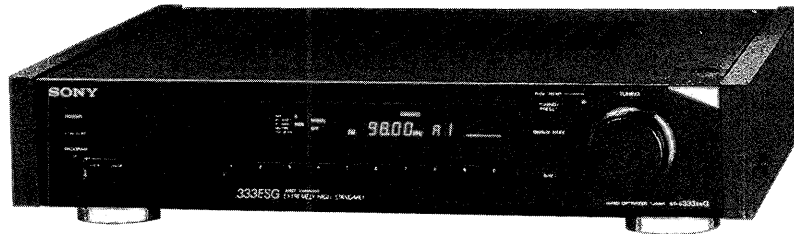

SPECIFICATIONS

General

Circuit System	FM stereo, FM/AM super-heterodyne tuner PLL quartz-locked digital synthesizer system	Weight	Approx. 6.4 kg (14 lb 2 oz)
Power requirements	120V, 220 – 240V AC adjustable, 50/60Hz	Accessories Supplied	Connecting Cord (1) FM ribbon antenna (1) AM loop antenna (1) Antenna connector (1) Remote control cord (4-pin) (1) Short screw (M4 x 8) (4)
Power consumption	20 watts		
Dimension	Approx. 470 x 96 x 372 mm (w/h/d) (18 5/8 x 3 7/8 x 14 3/4 inches)		

FM STEREO / FM-AM TUNER
SONY®

FM tuner		
Tuning range		87.5-108 MHz
Intermediate frequency		10.7 MHz
Sensitivity	mono S/N 26 dB	10.3 dBf, 0.9 μ V/75 ohms
	stereo S/N 46 dB	38.5 dBf, 23 μ V/75 ohms
Usable sensitivity		10.3 dBf, 0.9 μ V/75 ohms (IHF)
Signal-to-noise ratio	at 40 kHz deviation	95 dB (mono)
		86 dB (stereo)
Harmonic distortion		WIDE 0.008% (mono)
		0.02% (stereo)
		NARROW 0.04% (mono)
		0.08% (stereo)
Separation at 1 kHz		65 dB
Selectivity	at 400 kHz	WIDE 80 dB
		NARROW 90 dB
	at 300 kHz	WIDE 45 dB
		NARROW 70 dB
Output	at 40 kHz deviation	400 mV

AM tuner		
Tuning range		AM: 531–1602 kHz (9 kHz step) 530–1710 kHz (10 kHz step)
Intermediate frequency		450 kHz
Usable sensitivity		
MW	AM loop antenna	250 μ V/m
	External antenna	30 μ V/m
LW	AM loop antenna	700 μ V/m
	External antenna	200 μ V/m
Signal-to-noise ratio		54 dB
Harmonic distortion		0.3 %
Selectivity		at 9 kHz: 65 dB (NARROW) 50 dB (WIDE)

TABLE OF CONTENTS

<u>Section</u>	<u>Title</u>	<u>Page</u>
	Specifications	1
	Features	3
1.	GENERAL	
1-1.	Location and Function of Controls	4
1-2.	Broadcast Reception	5
1-2-1.	Tuning in Manually	5
1-2-2.	Tuning in Automatically	5
1-2-3.	Storing station frequency into memory	6
1-2-4.	Receiving a Stored Station	6
1-2-5.	Scanning Stored Stations Automatically	7
1-2-6.	Scanning Stored Stations Manually	7
2.	IC PIN FUNCTIONS	
2-1.	IC601 (μ PD75108CW-A76) Pin Functions	8
3.	BLOCK DIAGRAM	11
4.	ELECTRICAL ADJUSTMENTS	13
5.	DIAGRAMS	
5-1.	Printed Wiring Boards	17
5-2.	Schematic Diagram	21
5-3.	IC Block Diagram	24
5-4.	Semiconductor Lead Layouts	26
6.	EXPLODED VIEWS	
6-1.	CABINET ASSEMBLY	27
6-1.	CHASSIS ASSEMBLY	29
7.	ELECTRICAL PARTS LIST	31

Features

Precise Tuning with the large knob

The detected revolution of the tuning knob is under digital-control so that you can tune in the correct frequency and stored station easily.

This system employs a variable muting function that adjusts itself to the rotation speed of the TUNING knob and changes the muting time. This function realizes a feeling which is very close to that of an analog type tuner.

Direct comparator technology

An employed PLL IC allows the comparison frequency to be as high as the channel spacing frequency, thus eliminating the tendency of a low comparison frequency to slip into the audio range and degrade the signal-to-noise ratio.

Free from digital noise

When the tuning completes, the clock oscillator of the micro-computer stops. Since the received signal passes through only analog circuits, you can enjoy the pure sound without an interference.

Wave optimizer technology

The WOIS (Wave Optimized IF System) which makes the IF waveform optimum shape in stereo and monaural mode and the WODD (Wave Optimized Direct Detector) which forms the VCO oscillation waveform of the PLL detector ensure low distortion sound.

Program function

Using the program function, you can automatically tune in up to four stations which have been memorized in any sequence you want. Stations will be received one by one as the power is turned on and off by an optional audio timer.

SAFETY-RELATED COMPONENT WARNING!!

COMPONENTS IDENTIFIED BY MARK \triangle OR DOTTED LINE WITH MARK \triangle ON THE SCHEMATIC DIAGRAMS AND IN THE PARTS LIST ARE CRITICAL TO SAFE OPERATION. REPLACE THESE COMPONENTS WITH SONY PARTS WHOSE PART NUMBERS APPEAR AS SHOWN IN THIS MANUAL OR IN SUPPLEMENTS PUBLISHED BY SONY.

SECTION 1 GENERAL

This section is extracted from
instruction manual.

1-1. LOCATION AND FUNCTION OF CONTROLS

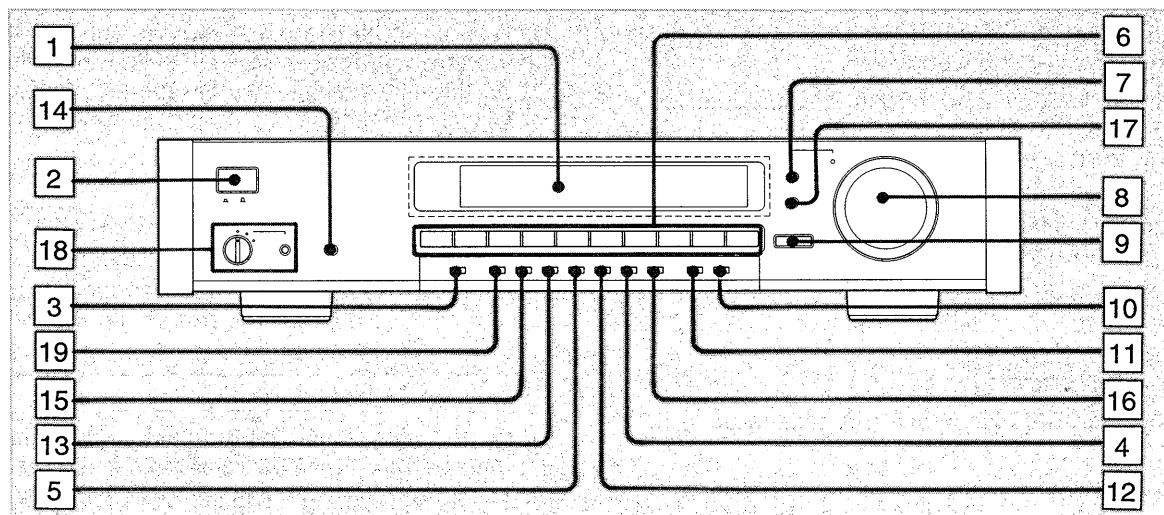

1 Display window

2 POWER switch

3 CAL TONE (calibrating tone) button

Press this button to obtain a 400 Hz, 50% modulated signal for adjusting the recording level on a cassette deck. "CAL" will appear when a 400 Hz calibrating tone signal is provided. To deactivate the calibrating tone circuit, press the button again.

4 TUNE MODE (tuning mode) button

5 MUTING button

6 PRESET buttons

7 TUNING/PRESET button

8 TUNING knob

9 SHIFT button

10 MEMORY button

11 Band selector

12 FM MODE button

Auto Stereo: Normally, select this mode (by making the HI-BLEND and MONO indicators disappear from the display window) when you tune in a strong FM broadcast.

HI-BLEND: Select this position when the high-frequency sound is noisy in the FM band. The high-frequency noise will be reduced, but this lowers the stereo effect.

MONO: Select this position when you tune in a very weak or noisy FM station. Although the sound will come out in monaural the noise will be greatly reduced.

13 IF (intermediate frequency) BAND button

To prevent inter-station interference, press this button. The NARROW indicator appears on the display and the selectivity is improved.

14 DISPLAY button

15 RF MODE button

16 MPX FILTER (multiplex filter) button

Press this button when you record an FM stereo program using the Dolby NR* (Noise Reduction) system. The MPX FILTER indicator appears.

This filter cuts off the 38 kHz subcarrier signals, which may otherwise interfere with proper operation of the Dolby NR* (Noise Reduction). If your deck has an MPX FILTER button, use that button rather than the button of this tuner.

* Dolby noise reduction manufactured under License from Dolby Laboratories Licensing Corporation. "DOLBY" and the double-D symbol  are trademarks of Dolby Laboratories Licensing Corporation.

17 DISPLAY MODE button

18 PROGRAM switch and CHECK button

19 ANT button

1-2. BROADCAST RECEPTION

1-2-1. Tuning in Manually

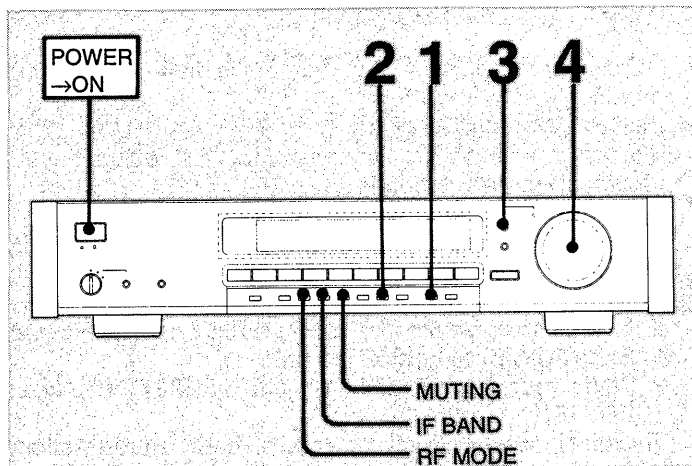

- 1** Select the desired band with the band selector.
- 2** If the AUTO indicator appears on the display, press **TUNE MODE**. The AUTO indicator disappears.
- 3** Check if the TUNING indicator appears on the display. If not, press TUNING/PRESET.
- 4** Find the desired station by turning the TUNING knob toward ► for higher frequencies or ◀ for lower frequencies.

For FM stereo reception

Normally, press MUTING.

MUTING indicator appears on the display. To tune in a very weak FM station, press again to reset it. The MUTING indicator goes off.

To receive a weak FM broadcast

Set MUTING off (press MUTING so that the MUTING indicator disappears from the display window), and if it is still noisy, set FM MODE to the MONO mode.

To tune in only stations with strong signals

Press RF MODE to make the DIRECT indicator appear.

When the desired station is interfered with adjacent stations

Press the IF BAND button so that the NARROW indicator appears in the display window. In this mode, the selectivity increases so that interference-free sound is obtained.

1-2-2. Tuning in Automatically

(FM only for European countries, FM and AM for other countries)

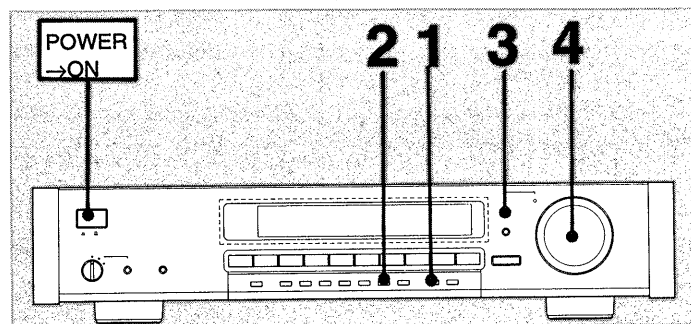

- 1** Select the desired band with the band selector.
- 2** Press **TUNE MODE** so that the AUTO indicator appears on the display.
- 3** Check if the TUNING indicator appears on the display. If not, press TUNING/PRESET.
- 4** Turn the TUNING knob toward ► for higher or ◀ for lower frequencies.
When automatic frequency scanning starts, release the knob. Scanning stops when a signal is received. If the signal is not the desired one, turn the knob again to restart scanning.

To receive other stations

When the received station is not the one you want, turn TUNING knob again.

To receive a strong FM broadcast

Normally, set MUTING on (press MUTING so that the MUTING indicator appears on the display) to reduce noise. Also, set FM MODE to the auto stereo mode. The unit operates in the stereo mode for a stereo signal, and automatically switches to the monaural mode for a monaural signal. If it is still noisy, set FM MODE to the HI-BLEND mode.

1-2-3. Storing station frequency into memory

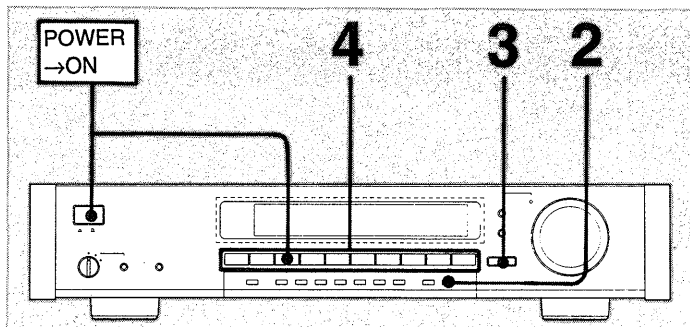

A total of 30 FM/AM stations (Station names can be stored only twenty among of thirty stations) in any band can be memorized.

Storing all stations automatically

To preset the frequencies and other modes of 30 stations, press the PRESET button 3 while pressing POWER.

To preset the frequencies, station names, and other modes of 20 stations, press the PRESET button 2 while pressing power.

Once they are presetted, they will be memorized. (Even for 1 month with the power off)

Storing one station at a time

- 1** Tune in the desired station.
- 2** Press MEMORY.
"MEMORY" appears in the window.
- 3** Press SHIFT to select the memory page A, B, or C.
- 4** Select a preset number with the PRESET button.

Repeat the above steps for each station to be stored in memory.

Notes on storing

If you select an incorrect number, press the MEMORY button again and select the correct number.

If the MEMORY indicator disappeared, before you pressed PRESET, press MEMORY again.

If the power remains off, the memory is maintained for approximately one month.

If a new station is stored over a preset station number, the previously stored station is erased.

If you set the ANTENNA, RF MODE, IF BAND, MUTING, they can be stored when you press MEMORY and PRESET.

If the indicators on the display are not properly displayed,

- 1 Press POWER to turn off the unit.
- 2 While pressing PRESET "9" and PRESET "0", press POWER to turn on the unit.

This unit is reset to initial state and all of the stored stations and settings are erased.

1-2-4. Receiving a Stored Station

Method A: When you know the preset number of the desired station.

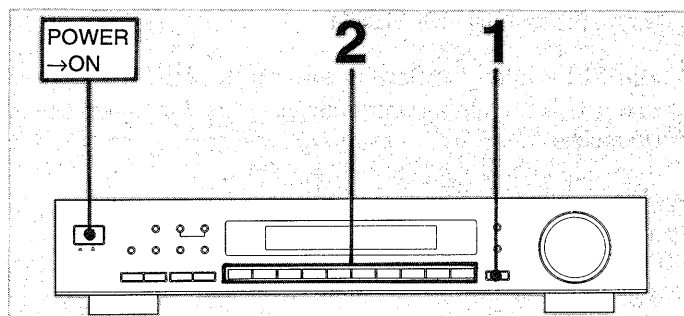

- 1** Press SHIFT to select the memory page A, B, or C.
- 2** Select the desired number with the PRESET button.

Method B: When you don't know the preset number of the desired station.

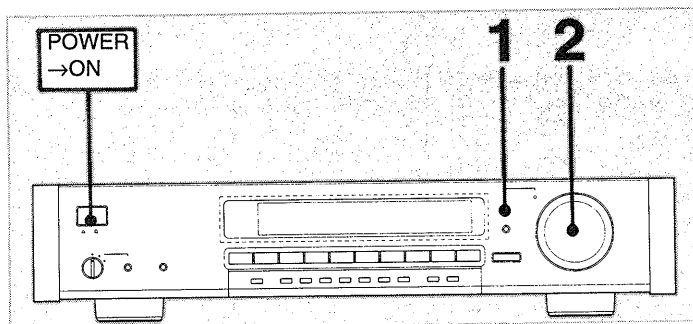

- 1** Press **TUNING/PRESET** to make the **PRESET** indicator appear.
- 2** Find the **desired station** by turning the **TUNING** knob control toward **▶** for higher numbered stations or **◀** for lower numbered stations.

1-2-5. Scanning Stored Stations Automatically

Press **TUNE MODE** to make "AUTO" appear and turn the **TUNING** knob.

If scanning does not start

Scanning starts only when you turn the **TUNING** knob while the code indicator is flashing. If the flashing has stopped, press **TUNE MODE** again.

1-2-6. Scanning Stored Stations Manually



1. Press **TUNING/PRESET** to make the **PRESET** indicator appear.
2. Press **TUNE MODE**.
AUTO indicator goes off.
3. Turn **TUNING/CHARACTER**, until desired station is received.

SECTION 2
IC PIN FUNCTIONS

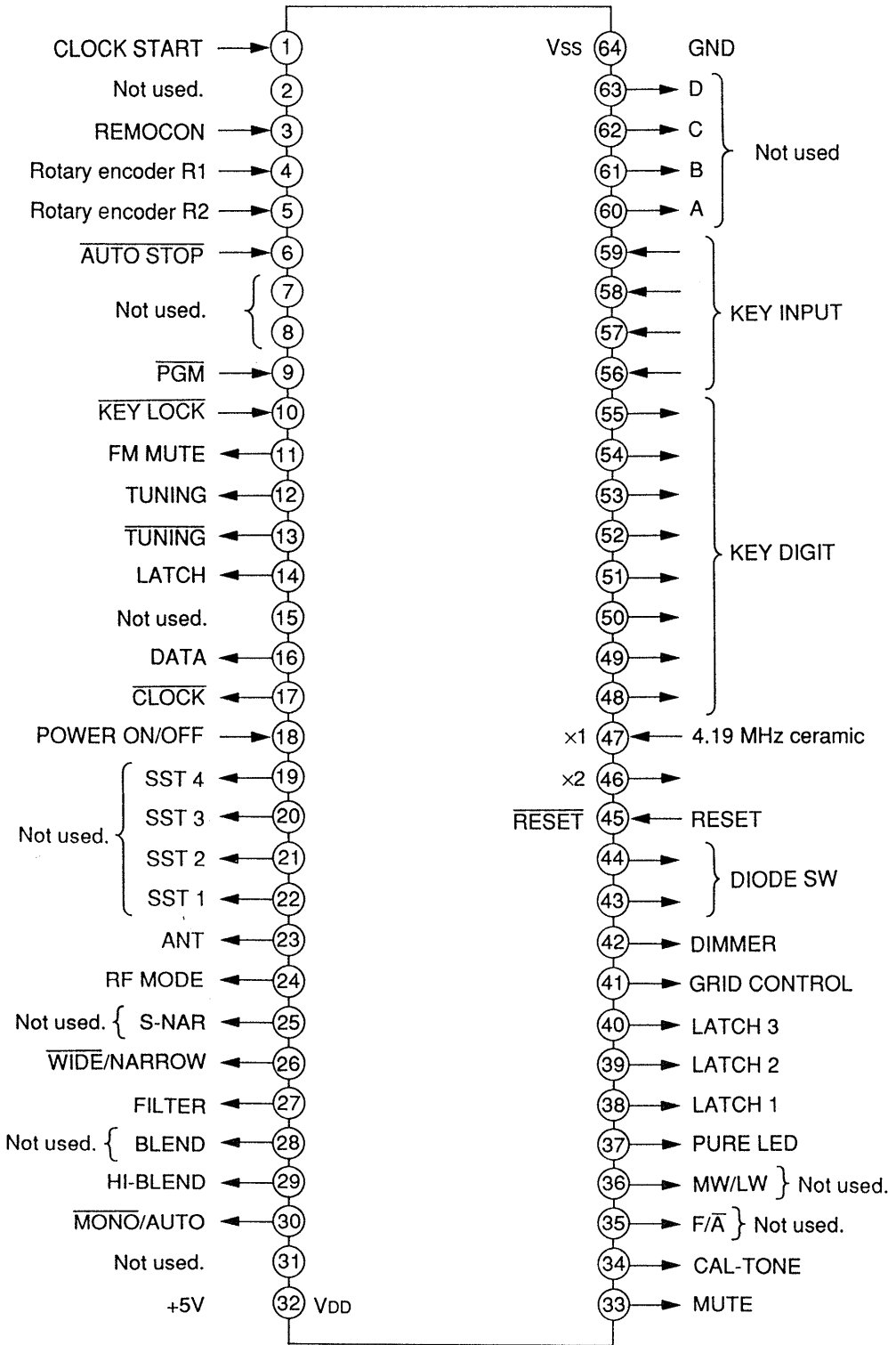
2-1. IC601 (μPD75108CW-A76) PIN FUNCTIONS



• IC601 SYSTEM CONTROLLER (μPD75108CW-A76) PIN FUNCTION

Pin No.	Pin Name	I/O	ACTIVE	Description
1	CLOCK START	I	H	Stop mode control input. (1) When there is no key input continuously for 2 seconds and the signal remains "L", the I/O port is maintained in the state immediately before and the stop mode is entered. PURE (pin 37) goes "H" and D701 lights. (2) When there is a key input,  releases the stop mode. PURE (pin 37) goes "L".
2	N.C.	I		Not used.
3	REMOCON	I		Remote control signal input.
4	R1	I		Rotary encoder rotation detect input (*1)
5	R2	I		Rotary encoder rotation detect input (*1)
6	AUTO STOP	I	L	Auto stop signal input from IC251. "L": when signal detect
7	N.C.	I		Not used.
8				
9	PGM	I	L	PROGRAM switch (S661) input. "L": PROGRAM
10	KEY LOCK	I	L	PROGRAM switch (S661) input. "L": KEY LOCK
11	F-MUT	O	H	FM MUTING output. "H": MUTE
12	TUN	O	H	FM MUTING SENS select output. "L": STOP, "H": TUNING
13	TUN	O	L	AM muting output. "H": STOP, "L": TUNING
14	LATCH	O	H	Signal meterdriver (IC705) latch output.
15	N.C.	I		
16	DATA	O	H	Display data output to FL driver (IC501, 701 – 703, 705)
17	CLK	O	L	Data transfer clock output to FL driver (IC501, 701 – 703, 705)
18	POWER	I	H	Power down detect input "H": normal, "L": power down
19 – 22	SST4 – SST1	O	H	Not used (pull up)
23	ANT	O	L	FM antenna select output. "L": antenna "A". "H": antenna "B"
24	RF MODE	O	H	Antenna attenuator ON/OFF output. "L": through, "H": ATT
25	S-NAR	O	H	Not used (pull up)
26	W/N	O	H	Wide/Narrow select output. "L": WIDE, "H": NARROW
27	FILTER	O	H	Multiplex filter switch. "H": MPX FILTER ON
28	BLD	O	H	Not used (pull up)
29	HI-B	O	H	HIGH BLEND switch (Q306) control output.
30	MONO/AUTO	O	H	Auto stereo select switch. "H": AUTO STEREO
31				Not used.
32	VDD	–		Power supply terminal (+5V)
33	MUT	O	H	Line mute output. "H": MUTE
34	CAL	O	L	CAL TONE ON/OFF output. "L": CAL TONE
35	F/A	O	H	Not used (open)

Pin No.	Pin Name	I/O	ACTIVE	Description
36	M/L	O	H	Not used.
37	PURE	O	H	PURE LED (D701) ON/OFF output. "H": ON (stop mode)
38	LATCH 1	O	H	FL driver (IC701) latch output
39	LATCH 2	O	H	FL driver (IC702) latch output
40	LATCH 3	O	H	FL driver (IC703) latch output
41	GRID	O	L	FL indicator tube grid control output (center grid 2G) (*2)
42	DIMMER	O	L	FL indicator tube grid control output (both sidesgrid 1G, 3G) (*2)
43 • 44	DIODE	O	H	Diode switch output.
45	RESET	I	L	System RESET input. "L": RESET
46	X2	O		Clock output
47	X1	I		Clock input (4.19 MHz)
48 – 55	KEY DI (S1)	O	H	Key matrix output
56 – 59	KEY INPUT	I	H	Key matrix input
60 – 63	LED A – LED D	O		Not used (pull down)
64	GND	–		Power supply terminal (GND)

*1 Rotary encoder rotation detect

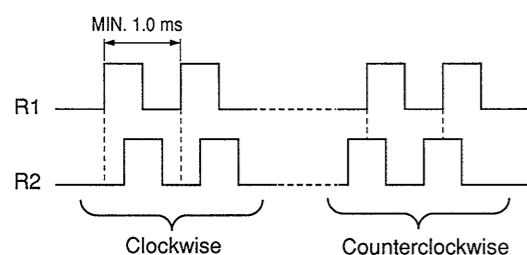

*2 When the **DISPLAY MODE** key is pressed, the FL display changes cyclically as follows.

→ Fully lit → Partially lit → Not lit

The output ports change as follows.

	Fully lit	Parcially	Not lit
41 pin GRID	L	L	H
42 pin DIMMER	L	H	H

* When the **BAND** key is pressed, the output ports change cyclically as shown in the table below.

	FM	MW
IC501 CX7925 8 pin AO	H	L
IC501 CX7925 9 pin BO	DON'T CARE	H

• TEST MODE

When the **SHIFT** key is held depressed and the power is turned on, all segments in the FL display light while the key is held, so simple checking can be done.

When the **SHIFT** key is released, normal operation is restored.

SECTION 3 BLOCK DIAGRAM

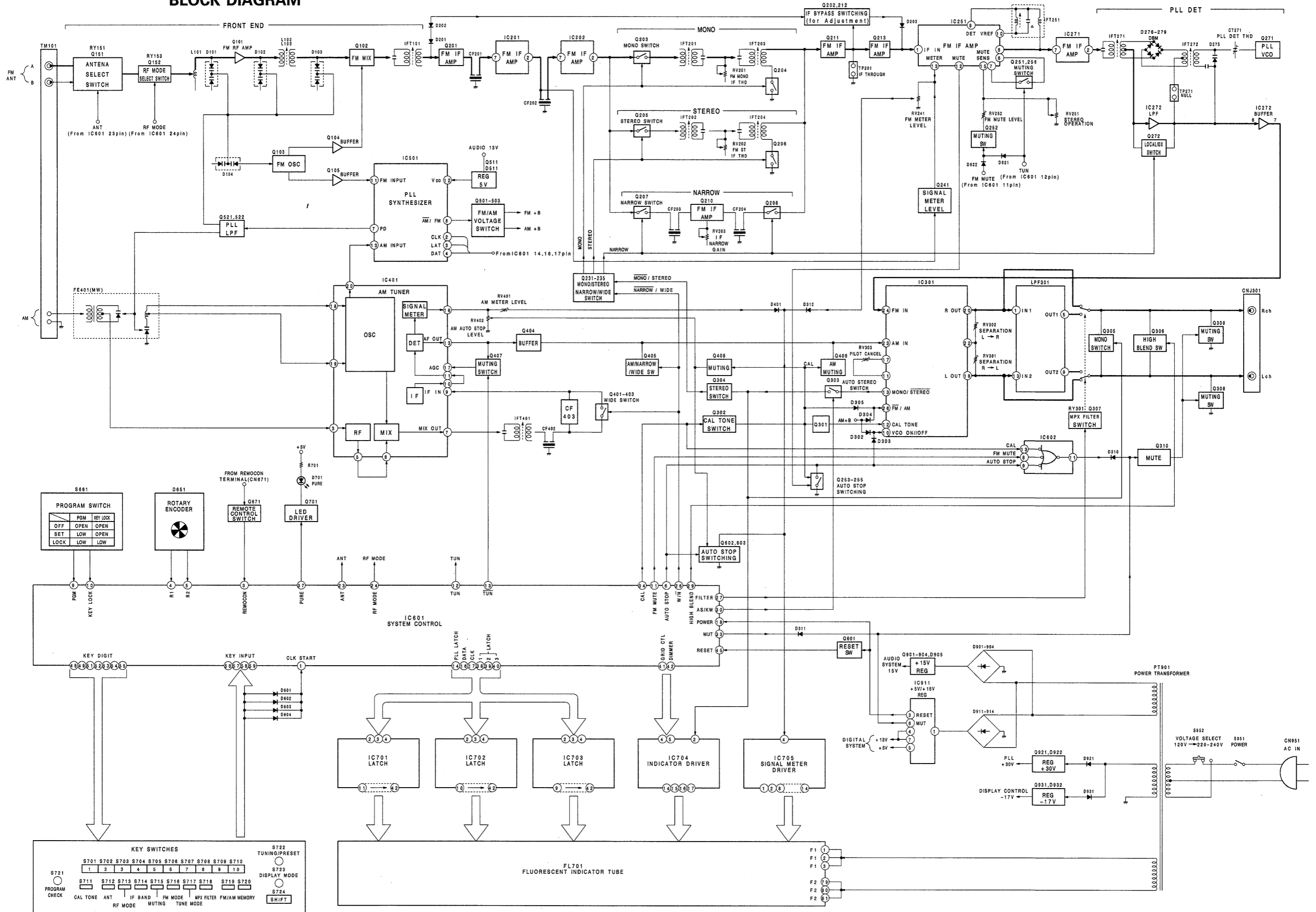

SECTION 4 ELECTRICAL ADJUSTMENTS

Notes: Perform adjustment in the order given.

• Parts location diagram relevant to the adjustment.

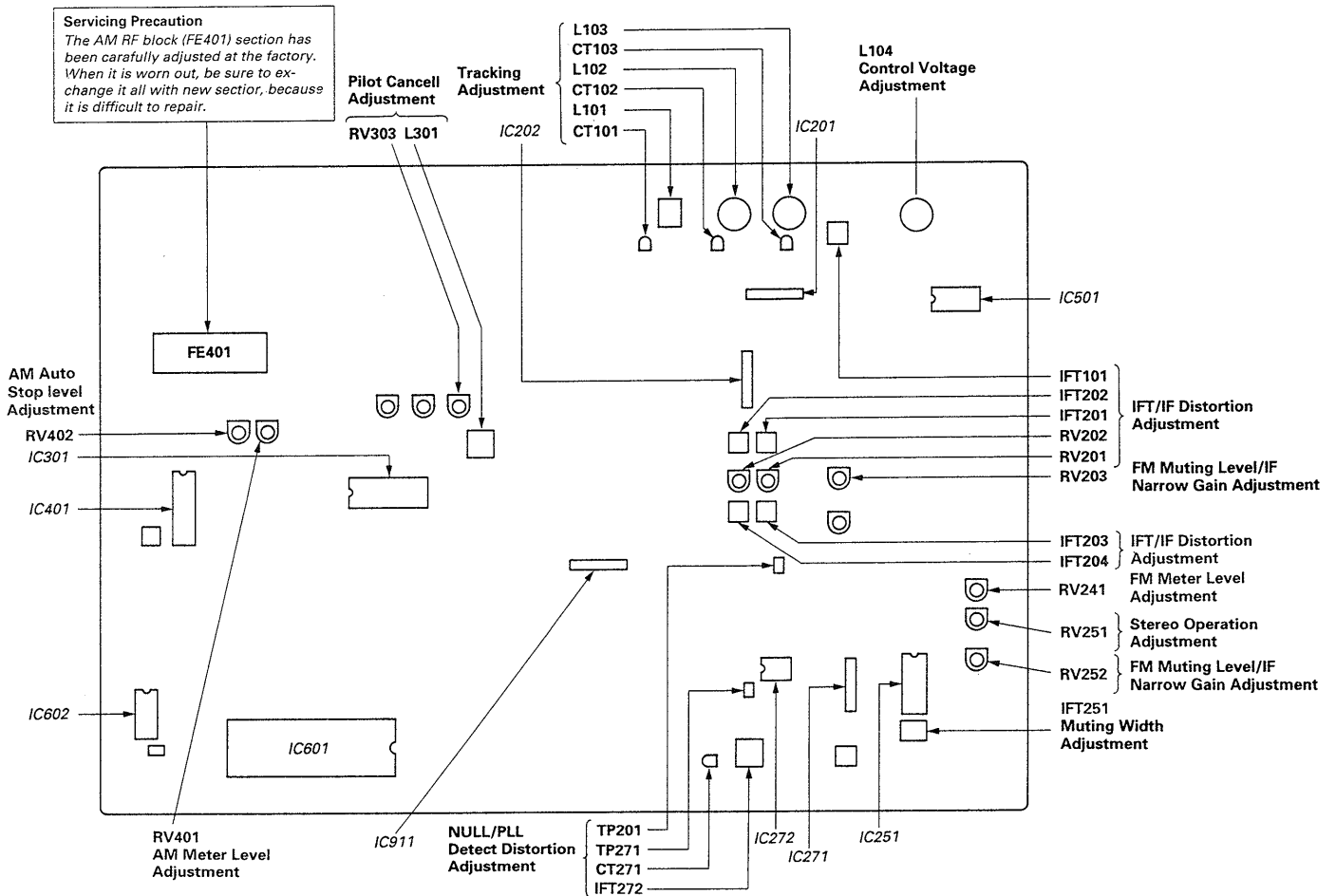

FM SECTION

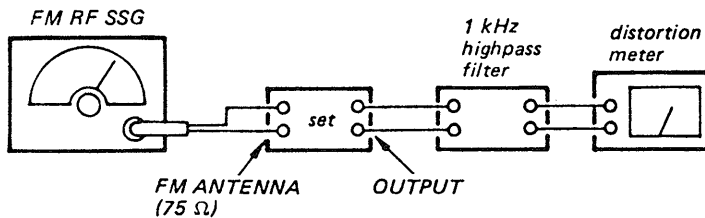

• Standard signals for adjustment.

FM RF Stereo Signal	FM RF Monaural Signal
Carrier frequency : 98 MHz	Carrier frequency : 98 MHz
Modulation : Audio 1 kHz, 16.25 kHz deviation (21.7%)	Modulation : Audio 1 kHz, 40 kHz deviation (53%)
Subchannel 16.25 kHz deviation (21.7%)	
Pilot 19 kHz, 7.5 kHz deviation (13.3%)	

Control Voltage Adjustment

Procedure:

1. Turn the set to 108 MHz.
2. Adjust L104 for 21.0 \pm 0.2 V reading on the VTVM.
3. Tune the set to 87.5 MHz.
4. Confirm that the voltage reading on the VTVM is within 8.0 \pm 1.0V.

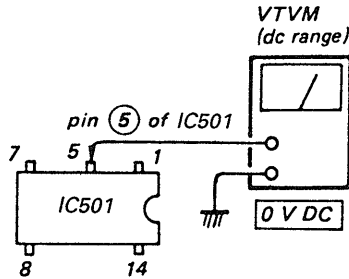

Tracking Adjustment

Setting:

IF BAND : NARROW

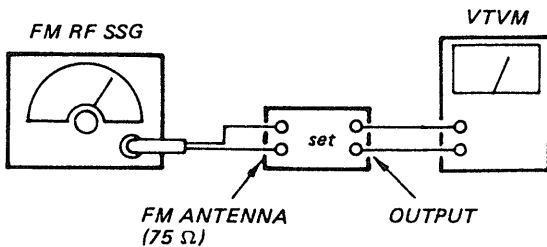

Procedure:

1. Tune the set to 108 MHz.
2. Adjust CT101, CT102 and CT103 for maximum reading on the VTVM.
3. Tune the set to 87.5 MHz.
4. Adjust L101, L102 and L103 for maximum reading on the VTVM.
5. Repeat the step 2 – 4 several times.

Muting Width Adjustment

Setting:

IF BAND : WIDE
MUTING switch : ON

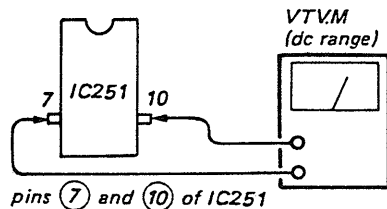
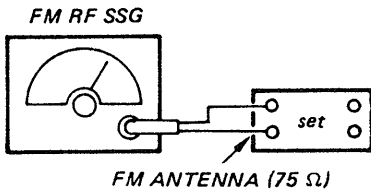

Carrier frequency: 98 MHz
Modulation: FM RF Monaural signal
Output level: 10 mV (80 dB μ)

Procedure:

1. Tune the set to 98 MHz.
2. Adjust IFT251 for 0V reading on the VTVM.

NULL/PLL Detect Distortion Adjustment

Setting:

IF BAND : WIDE
MUTING switch: ON

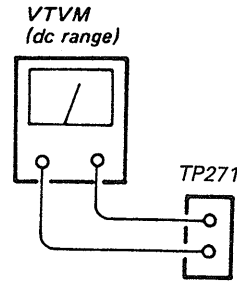

Procedure:

1. Tune the set to 98 MHz.
2. Short-circuit TP201 to the ground (The set turns into IF through state.)
3. Set the SSG output to 80 dB μ (10 mV).
4. Adjust IFT272 for 0 V reading on the VTVM (TP271). (Null adj.)
5. Adjust CT271 for minimum distortion reading on the distortion meter. (PLL Detect Distortion adj.)
6. Repeat the step 4 and 5 several times.
7. Remove the short circuit of TP201.

IFT/IF Distortion Adjustment

Setting:

IF BAND : WIDE
MUTING switch: OFF

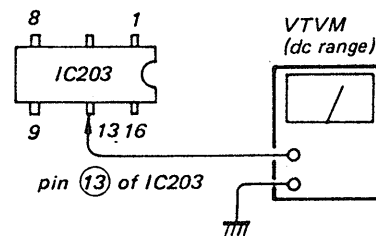

Procedure:

1. Tune the set to 98 MHz.
2. Turn RV201 and RV202 to fully clockwise.
3. Set the SSG output to 40 dB μ (100 μ V) at monaural modulation mode.
4. Adjust IFT201 for maximum reading on the VTVM. (IF Distortion Pre adj. • MONO)
5. Set the SSG output to 40 dB μ (100 μ V) at stereo modulation mode.
6. Adjust IFT202 for maximum reading on the VTVM. (IF Distortion Pre adj. • STEREO)
7. Adjust IFT101 for maximum reading on the VTVM (IFT adj.)
8. Set the SSG output to 80 dB μ (10 mV) at monaural modulation mode.
9. Turn RV201 and RV202 to mechanical center position.
10. Adjust IFT203 for the minimum distortion. (IF Distortion adj. • MONO)
11. Set the SSG output to 80 dB μ (10 mV) at stereo modulation mode. (Lch only)
12. Adjust IFT204 for the minimum distortion. (IF Distortion adj. • STEREO)

Stereo Operation Adjustment

Setting:

IF BAND : WIDE
MUTING switch: OFF
FM RF SSG

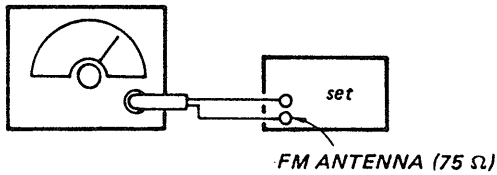

Carrier frequency: 98 MHz
Modulation: FM RF Stereo signal
Output level: 10 μV (20 dB)

Procedure:

1. Tune the set to 98 MHz.
2. Adjust RV251 so that the STEREO indicator goes on.

FM Muting Level/IF Narrow Gain Adjustment

Setting:

IF BAND : WIDE
MUTING switch: ON

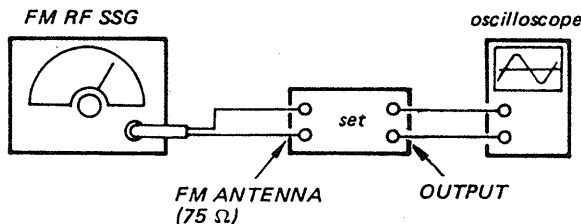

Carrier frequency: 98 MHz
Modulation: FM RF Monaural signal
Output level: 12.6 μV (22 dB)

Procedure:

1. Tune the set to 98 MHz and adjust output level of signal generator at 25 dBμ (17.8 μV).
2. Turn RV252 at the position where the waveform suddenly appears on the oscilloscope (FM Muting level adj.)
3. IF BAND : NARROW
4. Turn RV203 at the position where the waveform suddenly appears on the oscilloscope (IF Narrow Gain adj.)

FM Meter Level Adjustment

Setting:

IF BAND : WIDE

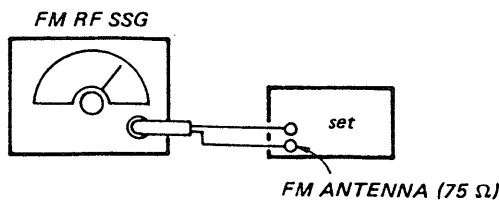

Carrier frequency: 98 MHz
Modulation: FM RF Monaural signal
Output level: 3 mV (70 dBμ)

Procedure:

1. Tune the set to 98 MHz.
2. Adjust RV241 so that 1 – 10 indication bars light up on the signal meter.

Pilot Cancell Adjustment

Setting:

IF BAND : WIDE
FM RF stereo signal generator

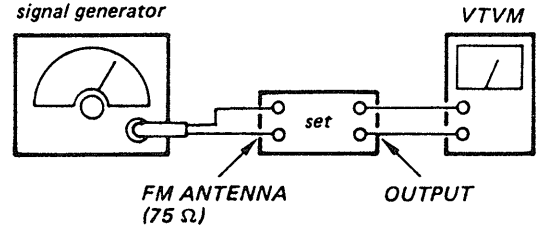

Carrier frequency: 98 MHz
Modulation: pilot only
Output level: 10 mV (80 dBμ)

Procedure:

1. Turn the set to 98 MHz.
2. Adjust RV303 and L301 alternately for minimum reading on the VTVM and also tune the both channel of L-CH and R-CH balanced at this time.
3. Repeat the step 2 several times.

Stereo Separation Adjustment

Setting:

IF BAND : WIDE

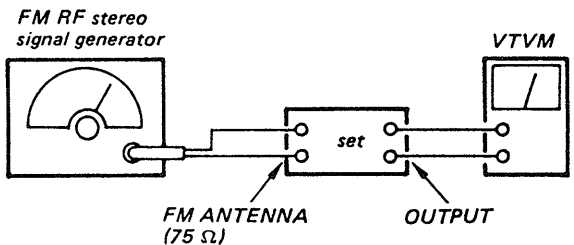

Carrier frequency: 98 MHz
Modulation: FM RF stereo signal
Output level: 10 mV (80 dBμ)

Procedure:

FM stereo signal generator output channel	VTVM connection	VTVM reading (dB)
L-CH	L-CH	Ⓐ
R-CH	L-CH	Ⓑ Adjust RV301 for minimum reading.
R-CH	R-CH	Ⓒ
L-CH	R-CH	Ⓓ Adjust RV302 for minimum reading.

L-CH Stereo separation: Ⓐ – Ⓑ

R-CH Stereo separation: Ⓒ – Ⓓ

The separations of both channels should be equal.

SECTION 5 DIAGRAMS

AM SECTION

Setting:

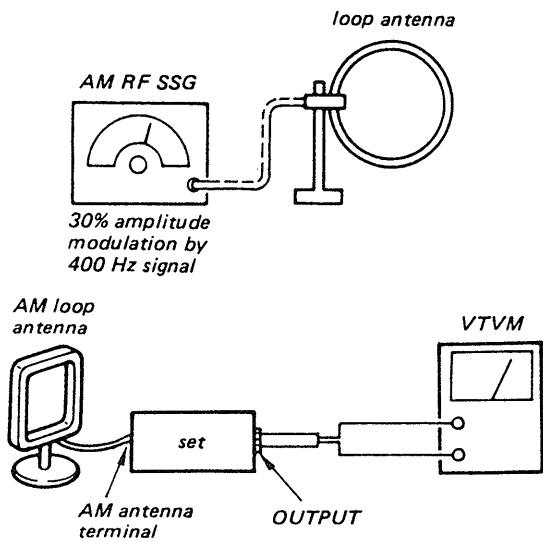

AM Meter Level Adjustment

Setting:

Carrier frequency: 216 kHz
Modulation: 400 Hz, 30% modulation

Procedure:

1. Set AM RF signal generator so that the AM antenna input level becomes 74 dB μ /m (5 mV/m.)
2. Adjust RV401 so that 1 – 10 indication bars light up on the signal meter.

AM Auto Stop Level Adjustment

Setting:

Carrier frequency: 999 kHz
Modulation: 400 Hz, 30% modulation

Procedure:

1. Set AM RF signal generator so that the AM antenna input level becomes 58 dB μ /m (0.8 mV/m.)
2. Adjust RV402 for 2.5V reading on the VTVM.

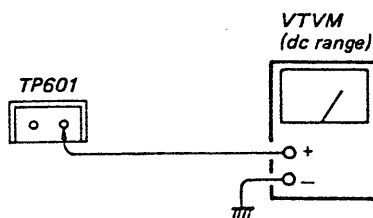

• Semiconductor Location

Ref. No.	Location	Ref. No.	Location	Ref. No.	Location
D101	C-19	D624	J-21	Q232	D-17
D102	B-18	D625	J-21	Q233	D-17
D103	B-17	D651	H-29	Q234	D-17
D104	B-15	D671	B-26	Q235	E-17
D151	B-21	D701	G-1	Q241	D-16
D152	B-20	D703	G-11	Q251	I-16
D201	C-17	D901	E-20	Q252	H-15
D202	C-17	D902	D-20	Q253	H-15
D203	G-16	D903	E-20	Q254	I-15
D241	E-16	D904	D-20	Q255	I-15
D242	E-16	D905	E-19	Q256	I-15
D273	I-19	D911	F-20	Q271	I-19
D274	H-19	D912	F-20	Q272	I-18
D275	I-18	D913	F-20	Q301	F-22
D276	I-17	D914	F-20	Q302	G-26
D277	I-17	D921	F-19	Q303	F-22
D278	I-17	D922	F-19	Q304	F-21
D279	I-17	D931	F-19	Q305	B-23
D301	F-23	D932	G-19	Q306	B-23
D302	F-22	IC201	C-18	Q307	C-23
D303	F-22	IC202	E-18	Q308	B-24
D304	F-23	IC251	I-16	Q309	B-24
D305	F-23	IC271	I-16	Q310	H-26
D306	C-22	IC272	H-17	Q401	G-26
D307	H-26	IC301	F-23	Q402	G-25
D310	H-25	IC401	F-25	Q403	G-25
D311	H-25	IC501	C-15	Q404	G-25
D312	G-15	IC601	J-24	Q405	G-25
D313	H-26	IC602	I-26	Q406	G-25
D401	G-24	IC701	G-4	Q407	F-24
D402	G-24	IC702	G-6	Q408	G-26
D511	C-15	IC703	G-7	Q501	D-15
D601	I-21	IC704	H-11	Q502	D-15
D602	I-21	IC705	H-2	Q503	D-16
D603	I-21	IC911	G-20	Q511	C-16
D604	I-21	Q101	B-18	Q521	D-15
D605	H-25	Q102	B-17	Q522	E-15
D606	I-25	Q103	B-15	Q601	J-25
D607	I-26	Q104	B-16	Q602	G-25
D608	J-26	Q105	B-15	Q603	G-25
D609	J-21	Q151	B-21	Q671	C-25
D610	J-21	Q152	B-21	Q701	G-2
D611	J-21	Q201	C-16	Q901	D-19
D612	J-21	Q202	D-17	Q902	E-19
D613	J-22	Q203	E-17	Q903	E-19
D614	J-22	Q204	F-18	Q904	E-19
D615	J-22	Q205	E-18	Q921	E-19
D616	J-22	Q206	F-18	Q931	G-18
D617	J-22	Q207	E-17		
D618	J-22	Q208	F-16		
D619	J-22	Q210	F-17		
D620	H-25	Q211	G-18		
D621	H-23	Q212	G-17		
D622	H-23	Q213	G-17		
D623	I-21	Q231	D-17		

* Repeat the procedure in AM Meter Level and AM Auto Stop Level adj. alternately several times.

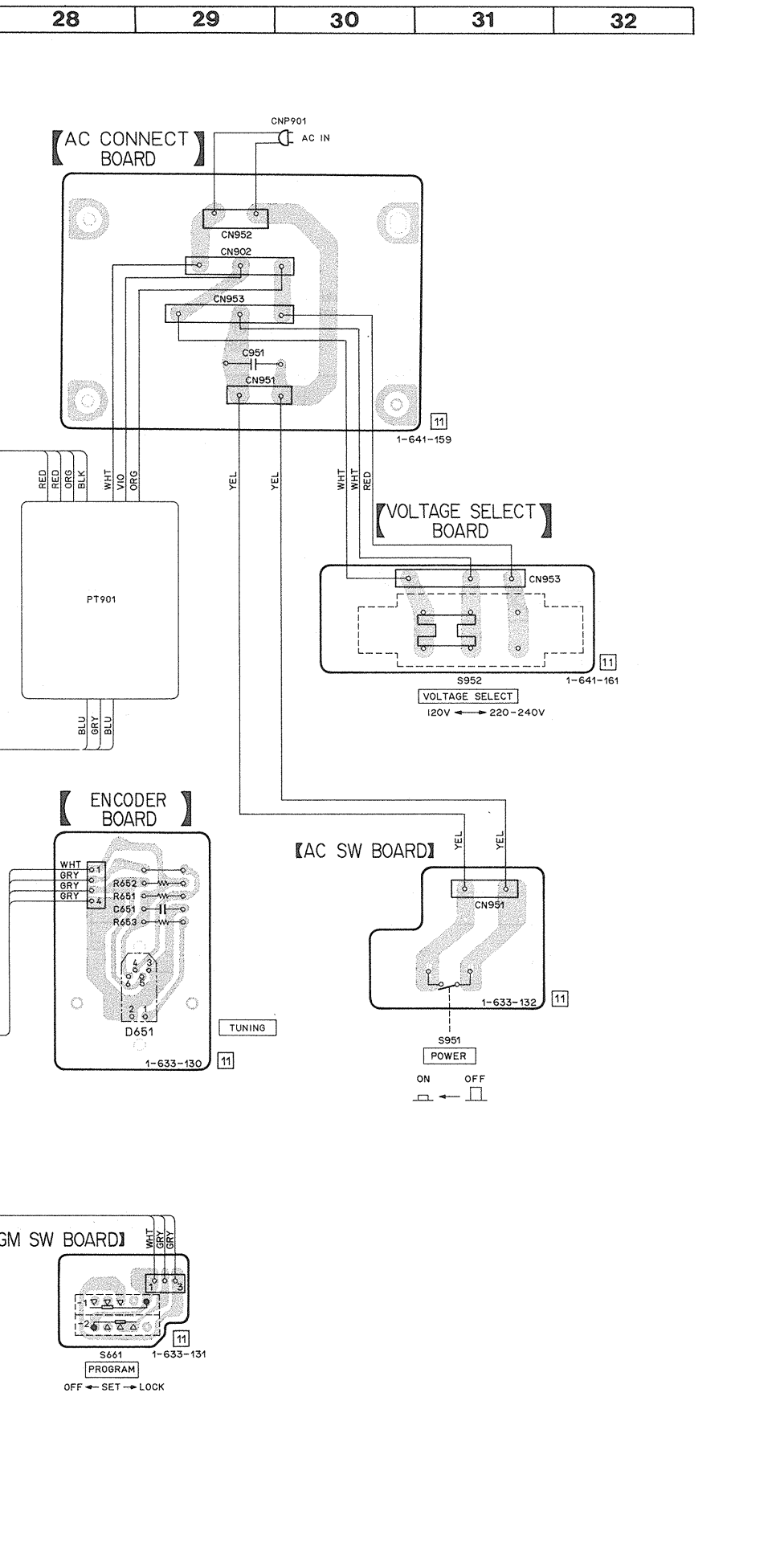
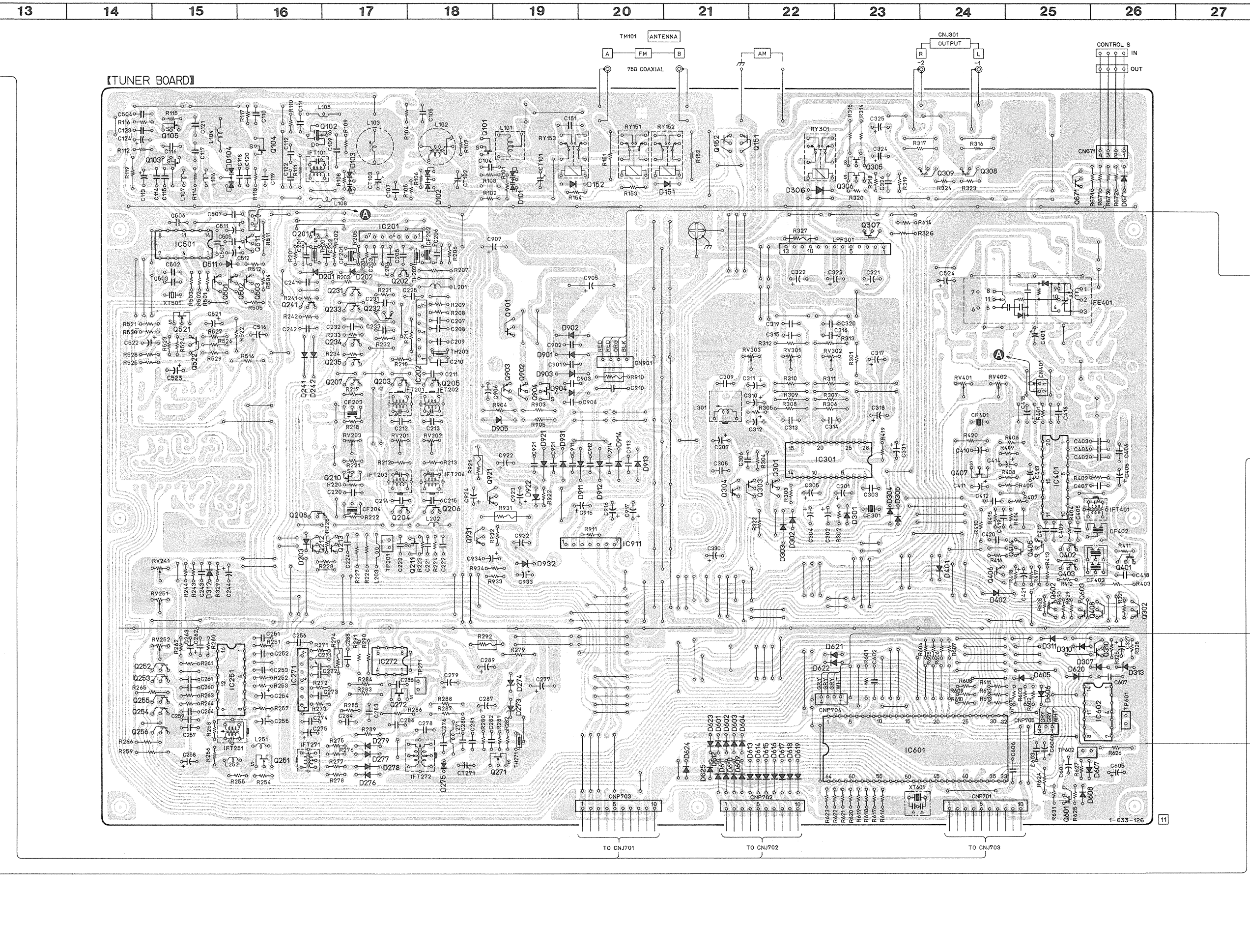
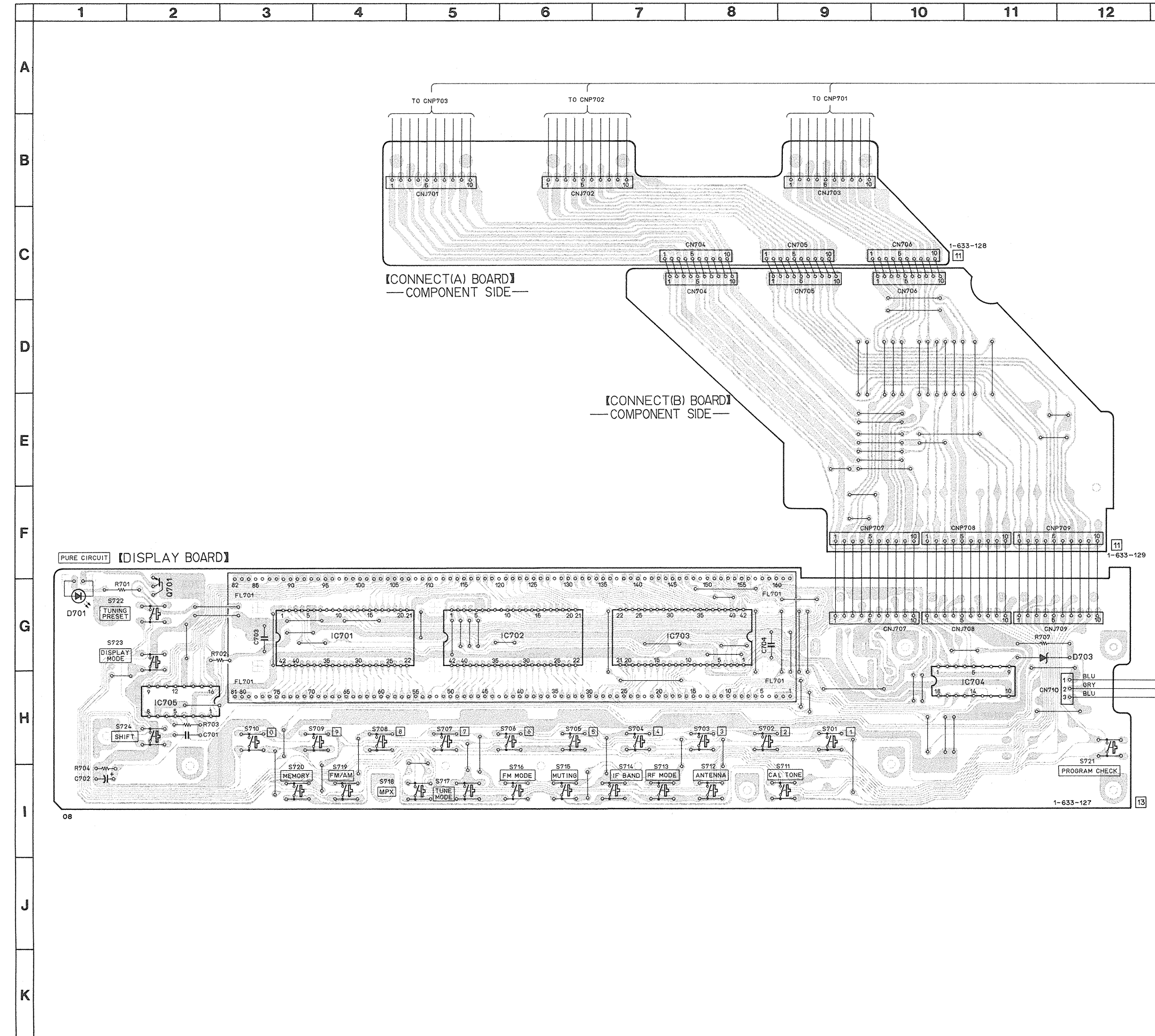

5-2. SCHEMATIC DIAGRAM • See page 24 for notes IC Block Diagrams. • See page 24 for waveforms.

- Note:
- All capacitors are in μF unless otherwise noted. pf: μpF 50WV or less are not indicated except for electrolytics and tantalums.
 - All resistors are in Ω and 1/4W or less unless otherwise specified.
 - Δ : internal component.
 - MW : fusible resistor.
 - \square : adjustment for repair.
 - Waveforms are taken with a VOM (50 k Ω/V). Voltage variations may be noted due to normal production tolerances.

- Note:
- Waveforms are taken with an oscilloscope. Voltage variations may be noted due to normal production tolerances.
 - Circled numbers refer to waveforms.
 - Voltage are dc with respect to ground under no-signal (detuned) condition.
 - no mark : FM () : MW
- The components identified by mark Δ or dotted line with mark Δ are critical for safety. Replace only with part number specified.

VOLTAGE AT IC601 PIN

PIN No.	VOLTAGE	PIN No.	VOLTAGE
1	0	24	RF DIRECT: 2.8
2	0	25	RF NORMAL: 0
3	4.8	26	0
4	4.8	27	NARROW: 2.3
5	4.8	28	0
6	0	29	MPX FILTER: 4.8
7	0	30	0
8	0	31	0
9	4.8	32	0
10	0	33	HI-BLEND: 13.1
11	0	34	MONO: 0
12	0	35	0
13	0	36	0
14	0	37	0
15	0	38	0
16	0	39	0
17	0	40	0
18	0	41	0
19	0	42	0
20	0	43	0
21	0	44	0
22	0	45	0

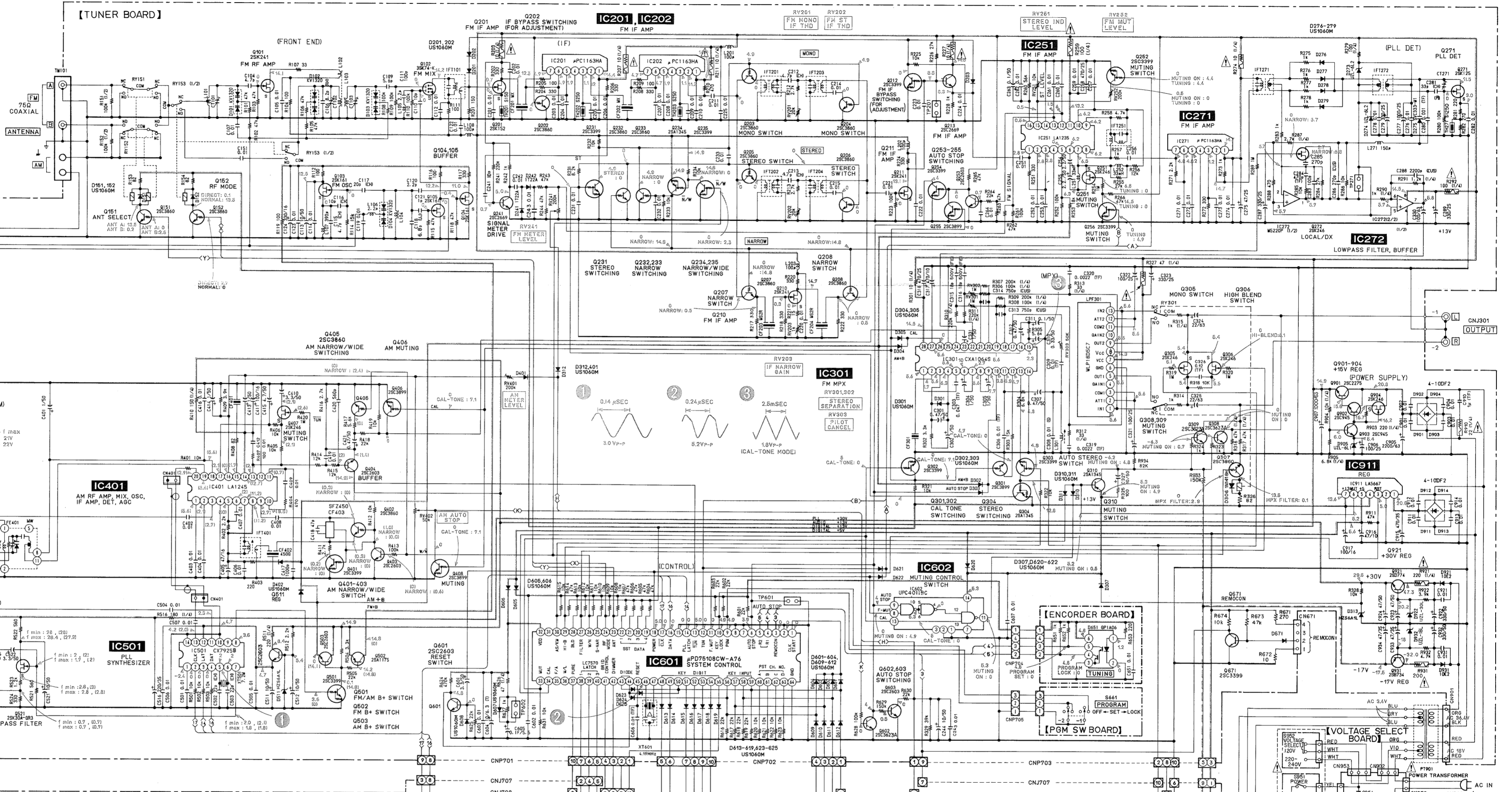

[DISPLAY BOARD]

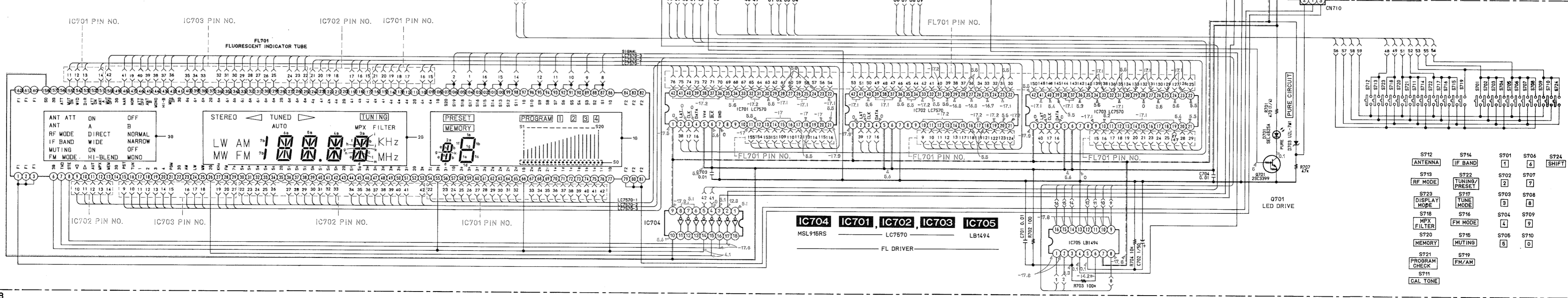

5-3. IC BLOCK DIAGRAM

IC201, 202, 271 μ PC1163HA

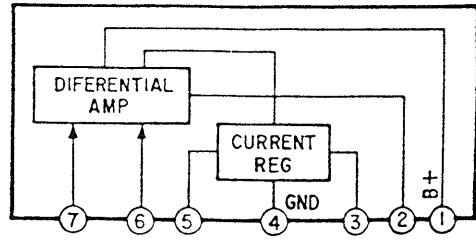

IC401 LA1245

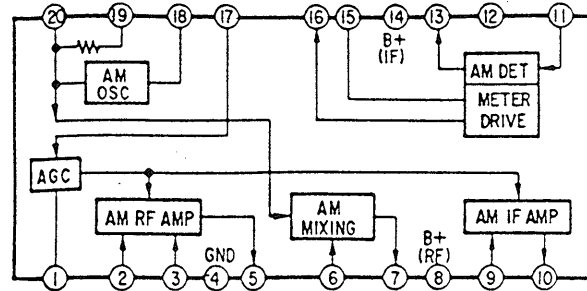

IC705 LB1494

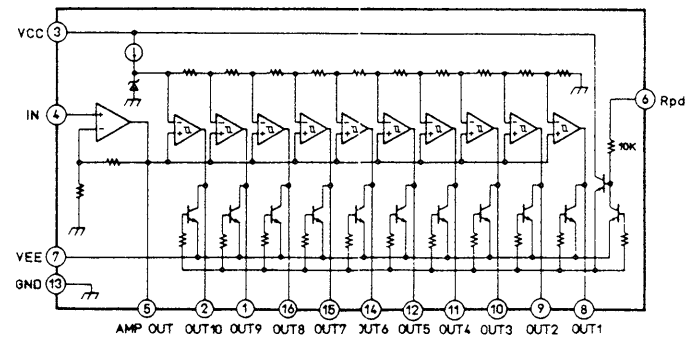

IC251 LA1235

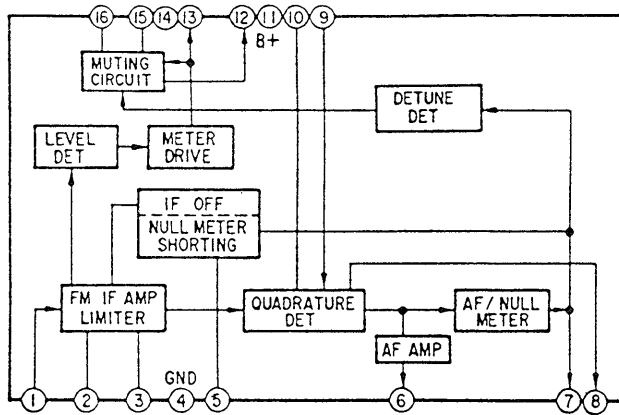

IC501 CX7925B

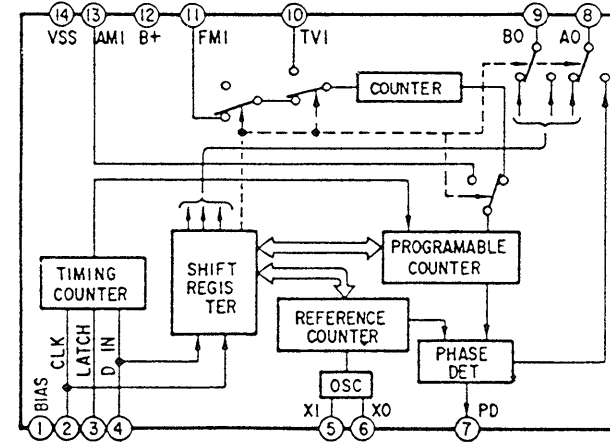

IC301 CXA1064S

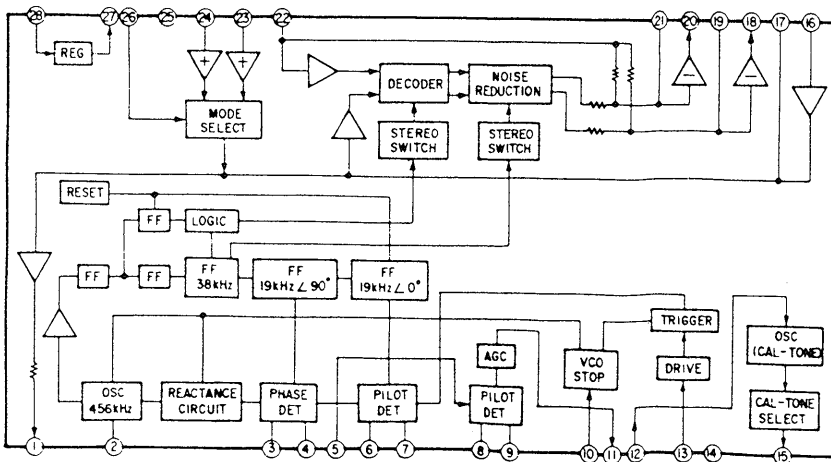

IC701, 702, 703 LC7570

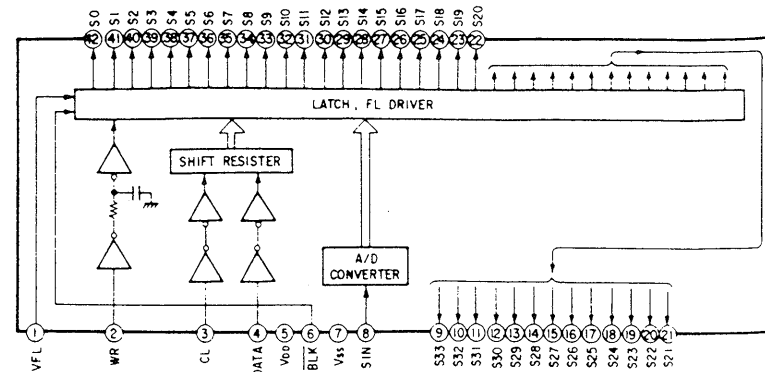

5-4. SEMICONDUCTOR LEAD LAYOUTS

LA5667

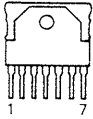

μPC1163HA

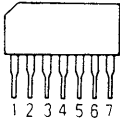

DTA144ES
DTC114ES
DTC114TS
DTC144ES
2SA1175-HFE
2SC2603-EF
2SC2669-0Y
2SC2785-HFE
2SC3623A-LK
2SC3899

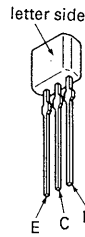

2SA1409-LK
2SC1815-GR

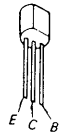

2SB734-34
2SD774-34



2SC2275-P



2SK125-3
2SK246-GR2
2SK30A-GR3

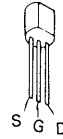

2SK152-3

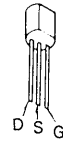

2SK161-GR
2SK241-Y



3SK122K

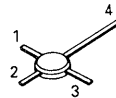

1. GATE 2
2. GATE 1
3. SOURCE
4. DRAIN

GP-1A06

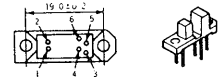

1. anode 3. GND 5. V01
2. cathode 4. V02 6. Vcc

KV1320

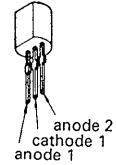

HZS30-2L
HZS-6A1L
HZS-6A3L
UZL-7M1
1SS120
1T22A
11ES2

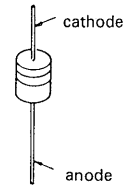

SEL4825A

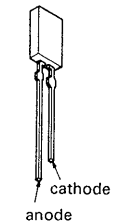

SVC333

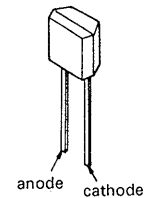

6-2. CHASSIS ASSEMBLY

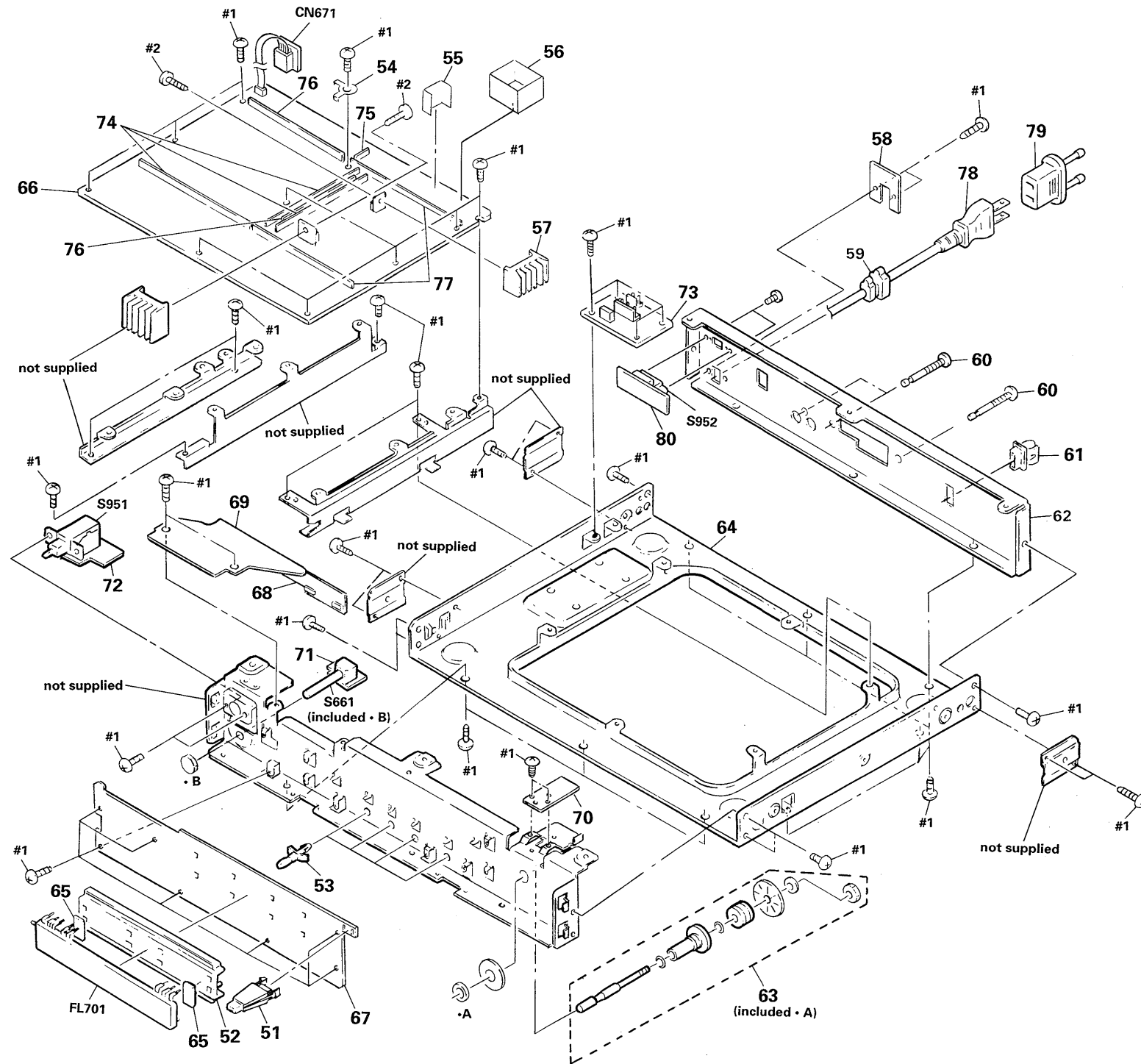

Ref.No.	Part No.	Description	Remark
51	* 3-304-605-11	HOLDER (NO.1), LED	
52	* 4-923-499-01	HOLDER (FL)	
53	* 3-703-353-01	SUPPORT, PC BOARD	
54	* 3-346-266-21	PLATE, GROUND	
55	* 4-911-325-01	PLATE (A), SHIELD	
56	* 2-287-441-01	PLATE, SHIELD	
57	* 4-921-402-01	HEAT SINK	
58	* 4-923-873-01	BRACKET, CORD STOPPER	
59	2-352-626-01	BUSHING, CORD	
60	3-704-242-01	SCREW, TERMINAL, + BVTP CLAW	
61	* 4-908-019-01	HOLDER (A), ANTENNA	
62	* 4-923-498-23	PANEL, BACK	
63	* X-4886-023-1	PLATE ASSY, SLIT	
64	* 4-908-042-11	CHASSIS, MAIN	
65	* 4-923-479-01	SPACER	
66	* A-4345-298-A	TUNER BOARD, COMPLETE	
67	* 1-633-127-11	DISPLAY BOARD	
68	* 1-633-128-11	CONNECT (A) BOARD	
69	* 1-633-129-11	CONNECT (B) BOARD	
70	* 1-633-130-11	ENCODER BOARD	
71	* 1-633-131-11	PGM SW BOARD	
72	* 1-633-132-11	AC SW BOARD	
73	* 1-641-159-11	AC CONNECTOR BOARD	
74	* 1-560-242-51	BUS BAR 7P	
75	* 1-560-242-61	BUS BAR 2P	
76	* 1-560-242-71	BUS BAR 6P	
77	* 1-560-242-91	BUS BAR 10P	
78	△ 1-559-297-31	CODE, POWER	
79	△ 1-569-007-11	ADAPTER, CONVERSION 2P	
80	* 1-641-161-11	VOLTAGE SELECT BOARD	
CN671	* 1-599-135-41	CORD (WITH CONNECTOR)	
FL701	1-519-558-11	INDICATOR TUBE, FLOURESCENT	
S661	1-571-333-11	SWITCH, ROTARY	
S951	△ 1-572-267-21	SWITCH, PUSH (AC POWER) (1 KEY)	
S952	△ 1-572-944-11	SWITCH, POWER VOLTAGE SELECTION	

The components identified by mark △ or dotted line with mark △ are critical for safety. Replace only with part number specified.

SECTION 7 ELECTRICAL PARTS LIST

DISPLAY
CONNECT(A)
CONNECT(B)
ENCODER

PGM SW
AC SW
AC CONNECTOR
VOLTAGE SELECT

- Due to standardization, replacements in the parts list may be different from the parts specified in the diagrams or the components used on the set.
- XX, X mean standardized parts, so they may have some difference from the original one.
- RESISTORS
All resistors are in ohms.
METAL : Metal-film resistor
METAL OXIDE : Metal Oxide-film resistor
F : nonflammable

- Items marked " *" are not stocked since they are seldom required for routine service. Some delay should be anticipated when ordering these items.
- SEMICONDUCTORS
In each case, u: μ , for example:
uA... : μ A..., uPA... : μ PA..., uPB... : μ PB,
uPC... : μ PC..., uPD...: μ PD
- CAPACITORS
uF: μ F
- COILS
uH: μ H

The components identified by mark Δ or dotted line with mark Δ are critical for safety.
Replace only with part number specified.

When indicating parts by reference number, please include the board name.

Ref. No.	Part No.	Description	Remark
	* 1-633-127-11	DISPLAY BOARD *****	
	* 1-633-128-11	CONNECT (A) BOARD *****	
	* 1-633-129-11	CONNECT (B) BOARD *****	
	* 1-633-130-11	ENCODER BOARD *****	
	* 1-633-131-11	PGM SW BOARD *****	
	* 1-633-132-11	AC SW BOARD *****	
	* 1-641-159-11	AC CONNECTOR BOARD *****	
	* 1-641-161-11	VOLTAGE SELECT BOARD *****	
	* 3-304-605-11	HOLDER (NO. 1), LED	
	* 4-923-479-01	SPACER	
	* 4-923-499-01	HOLDER (FL)	
< CAPACITOR >			
C651	1-161-379-00	CERAMIC	0.01uF 20% 25V
C701	1-161-379-00	CERAMIC	0.01uF 20% 25V
C702	1-124-903-11	ELECT	1uF 20% 50V
C703	1-161-379-00	CERAMIC	0.01uF 20% 25V
C704	1-161-379-00	CERAMIC	0.01uF 20% 25V
C951	1-161-744-00	CERAMIC	0.01uF 400V
< CONNECTOR >			
CN704	1-564-610-41	CONNECTOR, BOARD TO BOARD	10P
CN705	1-564-610-41	CONNECTOR, BOARD TO BOARD	10P
CN706	1-564-610-41	CONNECTOR, BOARD TO BOARD	10P
CN902	* 1-564-687-11	PIN, CONNECTOR	3P
CN952	* 1-564-321-00	PIN, CONNECTOR	2P

Ref. No.	Part No.	Description	Remark
CNJ701	* 1-565-486-11	CONNECTOR, BOARD TO BOARD	10P
CNJ702	* 1-565-486-11	CONNECTOR, BOARD TO BOARD	10P
CNJ703	* 1-565-486-11	CONNECTOR, BOARD TO BOARD	10P
CNJ707	* 1-565-486-11	CONNECTOR, BOARD TO BOARD	10P
CNJ708	* 1-565-486-11	CONNECTOR, BOARD TO BOARD	10P
CNJ709	* 1-565-486-11	CONNECTOR, BOARD TO BOARD	10P
CNP707	1-508-693-00	CONNECTOR PIN	10P
CNP708	1-508-693-00	CONNECTOR PIN	10P
CNP709	1-508-693-00	CONNECTOR PIN	10P
< DIODE >			
D651	8-719-913-37	DIODE	GP-1A06 (PURE CIRCUIT)
D701	8-719-304-52	DIODE	SEL4825A-C
D703	8-719-000-84	DIODE	UZL-7M1
< FLUORESCENT TUBE >			
FL701	1-519-558-11	INDICATOR TUBE, FLUORESCENT	
< IC >			
IC701	8-759-820-08	IC	LC7570
IC702	8-759-820-08	IC	LC7570
IC703	8-759-820-08	IC	LC7570
IC704	8-759-909-15	IC	MSL915RS
IC705	8-759-801-57	IC	LB1494
< TRANSISTOR >			
Q701	8-729-900-89	TRANSISTOR	DTC144ES
< RESISTOR >			
R651	1-249-417-11	CARBON	1K 5% 1/4W
R652	1-249-417-11	CARBON	1K 5% 1/4W
R653	1-249-409-11	CARBON	220 5% 1/4W
R701	1-247-708-11	CARBON	470 5% 1/4W

DISPLAY

CONNECT(A)

CONNECT(B)

ENCODER

PGM SW

AC SW

AC CONNECTOR

VOLTAGE SELECT

TUNER

Ref. No.	Part No.	Description	Remark		
R702	1-259-404-11	CARBON	100	5%	1/6W
R703	1-259-476-11	CARBON	100K	5%	1/6W
R704	1-259-452-11	CARBON	10K	5%	1/6W
R707	1-259-468-11	CARBON	47K	5%	1/6W

< SWITCH >

S661	1-571-333-11	SWITCH, ROTARY (PROGRAM)			
S701	1-554-303-21	SWITCH, TACTILE (1)			
S702	1-554-303-21	SWITCH, TACTILE (2)			
S703	1-554-303-21	SWITCH, TACTILE (3)			
S704	1-554-303-21	SWITCH, TACTILE (4)			
S705	1-554-303-21	SWITCH, TACTILE (5)			
S706	1-554-303-21	SWITCH, TACTILE (6)			
S707	1-554-303-21	SWITCH, TACTILE (7)			
S708	1-554-303-21	SWITCH, TACTILE (8)			
S709	1-554-303-21	SWITCH, TACTILE (9)			
S710	1-554-303-21	SWITCH, TACTILE (0)			
S711	1-554-303-21	SWITCH, TACTILE (CAL TONE)			
S712	1-554-303-21	SWITCH, TACTILE (ANT)			
S713	1-554-303-21	SWITCH, TACTILE (RF MODE)			
S714	1-554-303-21	SWITCH, TACTILE (IF BAND)			
S715	1-554-303-21	SWITCH, TACTILE (TUNING)			
S716	1-554-303-21	SWITCH, TACTILE (FM MODE)			
S717	1-554-303-21	SWITCH, TACTILE (TUNE MODE)			
S718	1-554-303-21	SWITCH, TACTILE (MPX)			
S719	1-554-303-21	SWITCH, TACTILE (FM/AM)			
S720	1-554-303-21	SWITCH, TACTILE (MEMORY)			
S721	1-554-303-21	SWITCH, TACTILE (PROGRAM CHECK)			
S722	1-554-303-21	SWITCH, TACTILE (TUNING PRESET)			
S723	1-554-303-21	SWITCH, TACTILE (DISPLAY MODE)			
S724	1-554-303-21	SWITCH, TACTILE (SHIFT)			
S951	1-572-267-21	SWITCH, PUSH (AC POWER) (1 KEY)			

* A-4345-298-A TUNER BOARD, COMPLETE

* 1-560-242-51 BUS BAR 7P
* 1-560-242-61 BUS BAR 2P
* 1-560-242-71 BUS BAR 6P
* 1-560-242-91 BUS BAR 10P

* 2-287-441-01 PLATE, SHIELD
* 3-346-266-21 PLATE, GROUND
* 4-911-325-01 PLATE (A), SHIELD
* 4-921-402-01 HEAT SINK
7-682-548-09 SCREW +B 3X8

Ref. No.	Part No.	Description	Remark		
		< CAPACITOR >			
C104	1-162-195-31	CERAMIC	4.7PF	10%	50V
C105	1-161-379-00	CERAMIC	0.01uF	20%	25V
C107	1-101-004-00	CERAMIC	0.01uF		50V
C109	1-162-196-31	CERAMIC	5.6PF	10%	50V
C110	1-162-199-31	CERAMIC	10PF	5%	50V
C111	1-162-282-31	CERAMIC	100PF	10%	50V
C112	1-161-379-00	CERAMIC	0.01uF	20%	25V
C113	1-124-907-11	ELECT	10uF	20%	50V
C114	1-161-379-00	CERAMIC	0.01uF	20%	25V
C115	1-162-195-31	CERAMIC	4.7PF	10%	50V
C116	1-162-199-31	CERAMIC	10PF	5%	50V
C117	1-162-206-31	CERAMIC	20PF	5%	50V
C118	1-162-197-31	CERAMIC	6.8PF	10%	50V
C119	1-101-004-00	CERAMIC	0.01uF		50V
C120	1-162-191-31	CERAMIC	2.2PF	10%	50V
C121	1-162-187-31	CERAMIC	1PF	20%	50V
C122	1-161-379-00	CERAMIC	0.01uF	20%	25V
C123	1-161-379-00	CERAMIC	0.01uF	20%	25V
C124	1-124-119-00	ELECT	330uF	20%	16V
C151	1-161-379-00	CERAMIC	0.01uF	20%	25V
C201	1-161-379-00	CERAMIC	0.01uF	20%	25V
C202	1-161-379-00	CERAMIC	0.01uF	20%	25V
C203	1-161-379-00	CERAMIC	0.01uF	20%	25V
C204	1-161-379-00	CERAMIC	0.01uF	20%	25V
C205	1-161-379-00	CERAMIC	0.01uF	20%	25V
C206	1-161-379-00	CERAMIC	0.01uF	20%	25V
C207	1-161-379-00	CERAMIC	0.01uF	20%	25V
C208	1-161-379-00	CERAMIC	0.01uF	20%	25V
C209	1-161-379-00	CERAMIC	0.01uF	20%	25V
C210	1-161-379-00	CERAMIC	0.01uF	20%	25V
C211	1-161-379-00	CERAMIC	0.01uF	20%	25V
C212	1-162-195-31	CERAMIC	4.7PF	10%	50V
C213	1-162-195-31	CERAMIC	4.7PF	10%	50V
C214	1-161-379-00	CERAMIC	0.01uF	20%	25V
C215	1-161-379-00	CERAMIC	0.01uF	20%	25V
C220	1-161-379-00	CERAMIC	0.01uF	20%	25V
C221	1-161-379-00	CERAMIC	0.01uF	20%	25V
C222	1-161-379-00	CERAMIC	0.01uF	20%	25V
C223	1-161-379-00	CERAMIC	0.01uF	20%	25V
C224	1-161-379-00	CERAMIC	0.01uF	20%	25V
C225	1-161-379-00	CERAMIC	0.01uF	20%	25V
C231	1-161-379-00	CERAMIC	0.01uF	20%	25V
C232	1-161-379-00	CERAMIC	0.01uF	20%	25V
C233	1-161-379-00	CERAMIC	0.01uF	20%	25V
C241	1-162-199-31	CERAMIC	10PF	10%	50V
C242	1-161-379-00	CERAMIC	0.01uF	20%	25V

TUNER

Ref. No.	Part No.	Description			Remark	Ref. No.	Part No.	Description			Remark
C243	1-161-379-00	CERAMIC	0.01uF	20%	25V	C315	1-102-953-00	CERAMIC	18PF	5%	50V
C244	1-124-907-11	ELECT	10uF	20%	50V	C316	1-102-953-00	CERAMIC	18PF	5%	50V
C251	1-161-379-00	CERAMIC	0.01uF	20%	25V	C317	1-124-997-11	ELECT	470uF	20%	10V
C252	1-161-379-00	CERAMIC	0.01uF	20%	25V	C318	1-126-026-11	ELECT	470uF	20%	25V
C253	1-161-379-00	CERAMIC	0.01uF	20%	25V	C319	1-130-475-00	MYLAR	0.0022uF	5%	50V
C254	1-124-925-11	ELECT	2.2uF	20%	100V	C320	1-130-475-00	MYLAR	0.0022uF	5%	50V
C255	1-124-925-11	ELECT	2.2uF	20%	100V	C321	1-126-023-11	ELECT	100uF	20%	25V
C256	1-161-379-00	CERAMIC	0.01uF	20%	25V	C322	1-126-023-11	ELECT	100uF	20%	25V
C257	1-161-379-00	CERAMIC	0.01uF	20%	25V	C323	1-126-025-11	ELECT	330uF	20%	25V
C258	1-126-026-11	ELECT	470uF	20%	25V	C324	1-124-929-11	ELECT	22uF	20%	100V
C259	1-161-379-00	CERAMIC	0.01uF	20%	25V	C325	1-124-929-11	ELECT	22uF	20%	100V
C260	1-161-379-00	CERAMIC	0.01uF	20%	25V	C326	1-136-166-00	FILM	0.12uF	5%	50V
C261	1-161-379-00	CERAMIC	0.01uF	20%	25V	C327	1-124-907-11	ELECT	10uF	20%	50V
C262	1-161-379-00	CERAMIC	0.01uF	20%	25V	C330	1-124-130-00	ELECT	100uF	20%	63V
C263	1-124-463-00	ELECT	0.1uF	20%	50V	C331	1-124-903-11	ELECT	1uF	20%	50V
C264	1-161-379-00	CERAMIC	0.01uF	20%	25V	C401	1-124-903-11	ELECT	1uF	20%	50V
C271	1-161-379-00	CERAMIC	0.01uF	20%	25V	C402	1-161-379-00	CERAMIC	0.01uF	20%	25V
C272	1-161-379-00	CERAMIC	0.01uF	20%	25V	C403	1-161-379-00	CERAMIC	0.01uF	20%	25V
C273	1-161-379-00	CERAMIC	0.01uF	20%	25V	C404	1-161-379-00	CERAMIC	0.01uF	20%	25V
C274	1-161-379-00	CERAMIC	0.01uF	20%	25V	C405	1-124-477-11	ELECT	47uF	20%	25V
C275	1-126-022-11	ELECT	47uF	20%	25V	C406	1-161-379-00	CERAMIC	0.01uF	20%	25V
C276	1-161-379-00	CERAMIC	0.01uF	20%	25V	C407	1-161-379-00	CERAMIC	0.01uF	20%	25V
C277	1-124-557-11	ELECT	1000uF	20%	25V	C408	1-161-379-00	CERAMIC	0.01uF	20%	25V
C278	1-161-379-00	CERAMIC	0.01uF	20%	25V	C409	1-161-379-00	CERAMIC	0.01uF	20%	25V
C279	1-126-025-11	ELECT	330uF	20%	25V	C410	1-123-382-00	ELECT	3.3uF	20%	100V
C280	1-130-471-00	MYLAR	0.001uF	5%	50V	C411	1-126-101-11	ELECT	100uF	20%	16V
C281	1-102-518-11	CERAMIC	33PF	5%	50V	C412	1-161-379-00	CERAMIC	0.01uF	20%	25V
C282	1-161-379-00	CERAMIC	0.01uF	20%	25V	C413	1-124-903-11	ELECT	1uF	20%	50V
C283	1-110-335-11	MYLAR	100PF	5%	50V	C414	1-124-903-11	ELECT	1uF	20%	50V
C284	1-130-467-00	MYLAR	470PF	5%	50V	C415	1-124-927-11	ELECT	4.7uF	20%	100V
C285	1-110-340-11	MYLAR	270PF	5%	50V	C416	1-161-379-00	CERAMIC	0.01uF	20%	25V
C286	1-110-340-11	MYLAR	270PF	5%	50V	C417	1-162-294-31	CERAMIC	0.001uF	10%	50V
C287	1-126-025-11	ELECT	330uF	20%	25V	C418	1-162-215-31	CERAMIC	47PF	5%	50V
C288	1-130-475-00	MYLAR	0.0022uF	5%	50V	C419	1-161-379-00	CERAMIC	0.01uF	20%	25V
C289	1-126-025-11	ELECT	330uF	20%	25V	C420	1-162-291-31	CERAMIC	560PF	10%	50V
C301	1-124-902-00	ELECT	0.47uF	20%	50V	C421	1-124-902-00	ELECT	0.47uF	20%	50V
C302	1-124-903-11	ELECT	1uF	20%	50V	C501	1-161-379-00	CERAMIC	0.01uF	20%	25V
C303	1-136-161-00	FILM	0.047uF	5%	50V	C502	1-102-959-00	CERAMIC	22PF	5%	50V
C304	1-124-903-11	ELECT	1uF	20%	50V	C503	1-102-959-00	CERAMIC	22PF	5%	50V
C305	1-124-903-11	ELECT	1uF	20%	50V	C504	1-161-379-00	CERAMIC	0.01uF	20%	25V
C306	1-130-483-00	MYLAR	0.01uF	5%	50V	C505	1-161-379-00	CERAMIC	0.01uF	20%	25V
C307	1-124-902-00	ELECT	0.47uF	20%	50V	C506	1-161-379-00	CERAMIC	0.01uF	20%	25V
C308	1-104-319-11	POLYSTYRENE	0.01uF	10%	50V	C507	1-161-379-00	CERAMIC	0.01uF	20%	25V
C309	1-130-483-00	MYLAR	0.01uF	5%	50V	C511	1-124-907-11	ELECT	10uF	20%	50V
C310	1-124-252-00	ELECT	0.33uF	20%	50V	C512	1-124-907-11	ELECT	10uF	20%	50V
C311	1-124-463-00	ELECT	0.1uF	20%	50V	C516	1-124-484-11	ELECT	220uF	20%	35V
C312	1-124-902-00	ELECT	0.47uF	20%	50V	C521	1-126-059-11	ELECT	10uF	20%	50V
C313	1-104-271-11	POLYSTYRENE	750PF	5%	50V	C522	1-123-382-00	ELECT	3.3uF	20%	100V
C314	1-104-271-11	POLYSTYRENE	750PF	5%	50V	C523	1-124-254-00	ELECT	0.68uF	20%	50V

TUNER

Ref. No.	Part No.	Description	Remark	Ref. No.	Part No.	Description	Remark
C524	1-124-463-00	ELECT	0.1uF 20% 50V	CNP701 *	1-506-608-11	PIN, CONNECTOR 10P	
C601	1-123-382-00	ELECT	3.3uF 20% 100V	CNP702 *	1-506-608-11	PIN, CONNECTOR 10P	
C602	1-161-379-00	CERAMIC	0.01uF 20% 25V	CNP703 *	1-506-608-11	PIN, CONNECTOR 10P	
C603	1-161-379-00	CERAMIC	0.01uF 20% 25V	CNP704 *	1-564-338-00	PIN, CONNECTOR 4P	
C604	1-131-377-00	TANTALUM	10uF 10% 10V	CNP705 *	1-564-337-00	PIN, CONNECTOR 3P	
C605	1-125-548-11	DOUBLE LAYERS	0.1F 5.5V			< TRIMMER >	
C606	1-161-379-00	CERAMIC	0.01uF 20% 25V	CT101	1-141-304-21	CAP, TRIMMER 10PF	
C607	1-161-379-00	CERAMIC	0.01uF 20% 25V	CT102	1-141-304-21	CAP, TRIMMER 10PF	
C901	1-101-004-00	CERAMIC	0.01uF 50V	CT103	1-141-304-21	CAP, TRIMMER 10PF	
C902	1-101-004-00	CERAMIC	0.01uF 50V	CT271	1-141-232-00	CAP, TRIMMER	
C903	1-101-004-00	CERAMIC	0.01uF 50V			< DIODE >	
C904	1-101-004-00	CERAMIC	0.01uF 50V	D101	8-719-901-59	DIODE KV1320	
C905	1-125-578-11	ELECT	2200uF 20%	D102	8-719-901-59	DIODE KV1320	
C906	1-126-023-11	ELECT	100uF 20% 25V	D103	8-719-901-59	DIODE KV1320	
C907	1-126-067-11	ELECT	1000uF 20% 63V	D104	8-719-901-59	DIODE KV1320	
C910	1-130-789-00	FILM	1uF 5% 100V	D151	8-719-912-20	DIODE 1SS120	
C911	1-101-004-00	CERAMIC	0.01uF 50V	D152	8-719-912-20	DIODE 1SS120	
C912	1-101-004-00	CERAMIC	0.01uF 50V	D201	8-719-912-20	DIODE 1SS120	
C913	1-101-004-00	CERAMIC	0.01uF 50V	D202	8-719-912-20	DIODE 1SS120	
C914	1-101-004-00	CERAMIC	0.01uF 50V	D203	8-719-912-20	DIODE 1SS120	
C915	1-126-104-11	ELECT	470uF 20% 35V	D241	8-719-022-21	DIODE 1T22A	
C916	1-124-126-00	ELECT	47uF 20% 10V	D242	8-719-022-21	DIODE 1T22A	
C917	1-126-101-11	ELECT	100uF 20% 16V	D273	8-719-933-35	DIODE HZS6A3L	
C921	1-101-004-00	CERAMIC	0.01uF 50V	D274	8-719-933-35	DIODE HZS6A3L	
C922	1-124-920-11	ELECT	330uF 20% 50V	D275	8-719-936-88	DIODE SVC333-M1-SONY	
C923	1-126-051-11	ELECT	47uF 20% 50V	D276	8-719-912-20	DIODE 1SS120	
C924	1-126-051-11	ELECT	47uF 20% 50V	D277	8-719-912-20	DIODE 1SS120	
C931	1-101-004-00	CERAMIC	0.01uF 50V	D278	8-719-912-20	DIODE 1SS120	
C932	1-124-912-11	ELECT	330uF 20% 50V	D279	8-719-912-20	DIODE 1SS120	
C933	1-124-910-11	ELECT	47uF 20% 50V	D301	8-719-912-20	DIODE 1SS120	
C934	1-124-910-11	ELECT	47uF 20% 50V	D302	8-719-912-20	DIODE 1SS120	
		< FILTER >		D303	8-719-912-20	DIODE 1SS120	
CF201	1-567-389-11	FILTER, CERAMIC		D304	8-719-912-20	DIODE 1SS120	
CF202	1-567-389-11	FILTER, CERAMIC		D305	8-719-912-20	DIODE 1SS120	
CF203	1-567-389-11	FILTER, CERAMIC		D307	8-719-912-20	DIODE 1SS120	
CF204	1-567-107-71	FILTER, CERAMIC		D310	8-719-912-20	DIODE 1SS120	
CF301	1-567-250-11	OSCILLATOR, CERAMIC		D311	8-719-912-20	DIODE 1SS120	
CF401	1-527-981-00	FILTER, CERAMIC		D312	8-719-912-20	DIODE 1SS120	
CF402	1-527-826-00	FILTER, CERAMIC		D313	8-719-933-33	DIODE HZS6A1L	
CF403	1-527-937-00	FILTER, CERAMIC		D401	8-719-912-20	DIODE 1SS120	
		< CONNECTOR >		D402	8-719-912-20	DIODE 1SS120	
CN671 *	1-559-135-41	CORD (WITH CONNECTOR) 4P		D511	8-719-933-33	DIODE HZS6A1L	
CN901 *	1-560-062-00	PIN, CONNECTOR 4P		D601	8-719-912-20	DIODE 1SS120	
CNJ301	1-563-560-11	JACK, PIN 2P		D602	8-719-912-20	DIODE 1SS120	
				D603	8-719-912-20	DIODE 1SS120	
				D604	8-719-912-20	DIODE 1SS120	

TUNER

Ref. No.	Part No.	Description	Remark
D605	8-719-912-20	DIODE 1SS120	
D606	8-719-912-20	DIODE 1SS120	
D607	8-719-912-20	DIODE 1SS120	
D608	8-719-912-20	DIODE 1SS120	
D609	8-719-912-20	DIODE 1SS120	
D610	8-719-912-20	DIODE 1SS120	
D611	8-719-912-20	DIODE 1SS120	
D612	8-719-912-20	DIODE 1SS120	
D613	8-719-912-20	DIODE 1SS120	
D614	8-719-912-20	DIODE 1SS120	
D615	8-719-912-20	DIODE 1SS120	
D616	8-719-912-20	DIODE 1SS120	
D617	8-719-912-20	DIODE 1SS120	
D618	8-719-912-20	DIODE 1SS120	
D619	8-719-912-20	DIODE 1SS120	
D620	8-719-912-20	DIODE 1SS120	
D621	8-719-912-20	DIODE 1SS120	
D622	8-719-912-20	DIODE 1SS120	
D623	8-719-912-20	DIODE 1SS120	
D624	8-719-912-20	DIODE 1SS120	
D625	8-719-912-20	DIODE 1SS120	
D671	8-719-912-20	DIODE 1SS120	
D901	8-719-200-82	DIODE 11ES2	
D902	8-719-200-82	DIODE 11ES2	
D903	8-719-200-82	DIODE 11ES2	
D904	8-719-200-82	DIODE 11ES2	
D905	8-719-933-33	DIODE HZS6A1L	
D911	8-719-200-82	DIODE 11ES2	
D912	8-719-200-82	DIODE 11ES2	
D913	8-719-200-82	DIODE 11ES2	
D914	8-719-200-82	DIODE 11ES2	
D921	8-719-200-82	DIODE 11ES2	
D922	8-719-934-22	DIODE HZS30-2L	
D931	8-719-200-82	DIODE 11ES2	
D932	8-719-002-06	DIODE UZL-18L	
< AM RF BLOCK >			
FE401	1-239-042-11	ENCAPSULATED COMPONENT (MW RF)	
< IC >			
IC201	8-759-111-72	IC μ PC1163HA	
IC202	8-759-111-72	IC μ PC1163HA	
IC251	8-759-812-35	IC LA1235	
IC271	8-759-111-72	IC μ PC1163HA	
IC272	8-759-602-01	IC M5220P	
IC301	8-759-802-57	IC CXA1064S	
IC401	8-759-812-45	IC LA1245	
IC501	8-757-925-20	IC CX-7925B	

Ref. No.	Part No.	Description	Remark
IC601	8-759-055-60	IC μ PD75108CW-C79	
IC602	8-759-140-11	IC UPD4011BC	
IC911	8-759-820-09	IC LA5667	
< COIL >			
IFT101	1-404-666-11	COIL, FM IFT	
IFT201	1-404-665-11	COIL, FM IFT (2)	
IFT202	1-404-665-11	COIL, FM IFT (2)	
IFT203	1-404-665-11	COIL, FM IFT (2)	
IFT204	1-404-665-11	COIL, FM IFT (2)	
IFT251	1-404-669-11	COIL, DISCRIMINATOR	
IFT271	1-404-668-11	COIL, FM DET (1)	
IFT272	1-404-667-11	COIL, FM DET (2)	
IFT401	1-404-326-00	TRANSFORMER, IF	
< COIL >			
L101	1-402-240-11	COIL (ANT)	
L102	1-426-249-11	COIL (RF)	
L103	1-459-647-11	COIL (WITH CORE)	
L104	1-459-618-11	COIL	
L105	1-410-967-11	INDUCTOR	2.2uH
L106	1-410-501-11	INDUCTOR	2.2uH
L107	1-408-988-21	INDUCTOR	390uH
L108	1-410-977-11	INDUCTOR	100uH
L201	1-410-977-11	INDUCTOR	100uH
L202	1-410-977-11	INDUCTOR	100uH
L203	1-410-977-11	INDUCTOR	100uH
L251	1-410-781-11	INDUCTOR	33mH
L252	1-410-781-11	INDUCTOR	33mH
L271	1-410-978-11	INDUCTOR	150uH
L301	1-409-413-11	COIL (TUNING)	
< FILTER >			
LPF301	1-236-560-11	ENCAPSULATED COMPONENT (LPF)	
< TRANSISTOR >			
Q101	8-729-200-55	TRANSISTOR	2SK241-Y
Q102	8-729-144-76	TRANSISTOR	3SK122K
Q103	8-729-216-13	TRANSISTOR	2SK161-GR
Q104	8-729-216-13	TRANSISTOR	2SK161-GR
Q105	8-729-216-13	TRANSISTOR	2SK161-GR
Q151	8-729-904-39	TRANSISTOR	DTC114TS
Q152	8-729-904-39	TRANSISTOR	DTC114TS
Q201	8-729-800-43	TRANSISTOR	2SK152-3
Q202	8-729-904-39	TRANSISTOR	DTC114TS
Q203	8-729-904-39	TRANSISTOR	DTC114TS
Q204	8-729-904-39	TRANSISTOR	DTC114TS
Q205	8-729-904-39	TRANSISTOR	DTC114TS
Q206	8-729-904-39	TRANSISTOR	DTC114TS

TUNER

Ref. No.	Part No.	Description	Remark			Ref. No.	Part No.	Description	Remark		
R226	1-249-434-11	CARBON	27K	5%	1/4W	R301	\triangle 1-212-857-00	FUSIBLE	10	5%	1/4W F
R227	\triangle 1-212-857-00	FUSIBLE	10	5%	1/4W F	R302	1-249-423-11	CARBON	3.3K	5%	1/4W
R228	1-249-417-11	CARBON	1K	5%	1/4W	R303	1-249-431-11	CARBON	15K	5%	1/4W
R231	1-249-428-11	CARBON	8.2K	5%	1/4W	R304	1-249-427-11	CARBON	6.8K	5%	1/4W
R232	1-249-429-11	CARBON	10K	5%	1/4W	R305	1-249-426-11	CARBON	5.6K	5%	1/4W
R233	1-249-429-11	CARBON	10K	5%	1/4W	R306	1-249-441-11	CARBON	100K	5%	1/4W
R234	1-249-429-11	CARBON	10K	5%	1/4W	R307	1-247-886-11	CARBON	200K	5%	1/4W
R241	1-247-887-00	CARBON	220K	5%	1/4W	R308	1-249-441-11	CARBON	100K	5%	1/4W
R242	1-249-417-11	CARBON	1K	5%	1/4W	R309	1-247-886-11	CARBON	200K	5%	1/4W
R243	1-249-437-11	CARBON	47K	5%	1/4W	R310	1-247-887-00	CARBON	220K	5%	1/4W
R244	1-249-437-11	CARBON	47K	5%	1/4W	R311	1-247-887-00	CARBON	220K	5%	1/4W
R251	1-249-411-11	CARBON	330	5%	1/4W	R312	1-249-399-11	CARBON	33	5%	1/4W
R252	1-249-441-11	CARBON	100K	5%	1/4W	R313	1-249-399-11	CARBON	33	5%	1/4W
R253	1-249-432-11	CARBON	18K	5%	1/4W	R314	1-249-417-11	CARBON	1K	5%	1/4W
R254	1-247-903-00	CARBON	1M	5%	1/4W	R315	1-249-417-11	CARBON	1K	5%	1/4W
R255	1-249-434-11	CARBON	27K	5%	1/4W	R316	1-249-437-11	CARBON	47K	5%	1/4W
R256	1-249-430-11	CARBON	12K	5%	1/4W	R317	1-249-437-11	CARBON	47K	5%	1/4W
R257	1-249-417-11	CARBON	1K	5%	1/4W	R318	1-249-429-11	CARBON	10K	5%	1/4W
R258	1-249-425-11	CARBON	4.7K	5%	1/4W	R319	1-247-903-00	CARBON	1M	5%	1/4W
R259	\triangle 1-212-881-11	FUSIBLE	100	5%	1/4W F	R320	1-247-903-00	CARBON	1M	5%	1/4W
R260	1-249-438-11	CARBON	56K	5%	1/4W	R321	1-249-429-11	CARBON	10K	5%	1/4W
R261	1-249-441-11	CARBON	100K	5%	1/4W	R322	1-249-429-11	CARBON	10K	5%	1/4W
R262	1-249-437-11	CARBON	47K	5%	1/4W	R323	1-249-417-11	CARBON	1K	5%	1/4W
R263	1-249-437-11	CARBON	47K	5%	1/4W	R324	1-249-417-11	CARBON	1K	5%	1/4W
R264	1-249-433-11	CARBON	22K	5%	1/4W	R325	1-249-405-11	CARBON	100	5%	1/4W
R265	1-249-437-11	CARBON	47K	5%	1/4W	R327	\triangle 1-212-873-11	FUSIBLE	47	5%	1/4W F
R266	1-249-437-11	CARBON	47K	5%	1/4W	R328	1-249-429-11	CARBON	10K	5%	1/4W
R271	1-249-421-11	CARBON	2.2K	5%	1/4W	R329	1-249-436-11	CARBON	39K	5%	1/4W
R272	1-249-411-11	CARBON	330	5%	1/4W	R401	1-249-429-11	CARBON	10K	5%	1/4W
R273	1-249-417-11	CARBON	1K	5%	1/4W	R402	1-249-421-11	CARBON	2.2K	5%	1/4W
R274	\triangle 1-212-857-00	FUSIBLE	10	5%	1/4W F	R403	\triangle 1-212-889-00	FUSIBLE	220	5%	1/4W F
R275	1-249-417-11	CARBON	1K	5%	1/4W	R404	1-249-413-11	CARBON	470	5%	1/4W
R276	1-249-417-11	CARBON	1K	5%	1/4W	R405	1-249-429-11	CARBON	10K	5%	1/4W
R277	1-249-417-11	CARBON	1K	5%	1/4W	R406	1-249-429-11	CARBON	10K	5%	1/4W
R278	1-249-417-11	CARBON	1K	5%	1/4W	R407	1-249-405-11	CARBON	100	5%	1/4W
R279	\triangle 1-212-881-11	FUSIBLE	100	5%	1/4W F	R408	1-249-404-00	CARBON	82	5%	1/4W
R280	1-249-441-11	CARBON	100K	5%	1/4W	R409	1-249-424-11	CARBON	3.9K	5%	1/4W
R281	1-249-409-11	CARBON	220	5%	1/4W	R410	\triangle 1-212-885-00	FUSIBLE	150	5%	1/4W F
R282	1-249-410-11	CARBON	270	5%	1/4W	R411	1-249-422-11	CARBON	2.7K	5%	1/4W
R283	1-249-417-11	CARBON	1K	5%	1/4W	R412	1-249-429-11	CARBON	10K	5%	1/4W
R284	1-249-434-11	CARBON	27K	5%	1/4W	R413	1-249-441-11	CARBON	100K	5%	1/4W
R285	1-249-429-11	CARBON	10K	5%	1/4W	R414	1-249-430-11	CARBON	12K	5%	1/4W
R286	1-249-429-11	CARBON	10K	5%	1/4W	R415	1-249-430-11	CARBON	12K	5%	1/4W
R287	1-249-422-11	CARBON	2.7K	5%	1/4W	R416	1-249-422-11	CARBON	2.7K	5%	1/4W
R288	1-249-413-11	CARBON	470	5%	1/4W	R417	1-249-426-11	CARBON	5.6K	5%	1/4W
R289	1-247-903-00	CARBON	1M	5%	1/4W	R418	1-249-433-11	CARBON	22K	5%	1/4W
R290	1-249-417-11	CARBON	1K	5%	1/4W	R419	1-249-429-11	CARBON	10K	5%	1/4W
R291	1-249-418-11	CARBON	1.2K	5%	1/4W	R420	1-247-903-00	CARBON	1M	5%	1/4W
R292	\triangle 1-212-881-11	FUSIBLE	100	5%	1/4W F	R501	1-249-429-11	CARBON	10K	5%	1/4W

The components identified by mark \triangle or dotted line with mark \triangle are critical for safety.
Replace only with part number specified.

TUNER

Ref. No.	Part No.	Description	Remark			Ref. No.	Part No.	Description	Remark		
R502	1-249-429-11	CARBON	10K	5%	1/4W	R672	1-249-393-11	CARBON	10	5%	1/4W
R503	1-249-429-11	CARBON	10K	5%	1/4W	R673	1-249-437-11	CARBON	47K	5%	1/4W
R504	1-249-423-11	CARBON	3.3K	5%	1/4W	R674	1-249-429-11	CARBON	10K	5%	1/4W
R505	1-249-433-11	CARBON	22K	5%	1/4W	R903	1-249-409-11	CARBON	220	5%	1/4W
R511	△ 1-212-889-00	FUSIBLE	220	5%	1/4W F	R904	1-249-429-11	CARBON	10K	5%	1/4W
R512	1-249-421-11	CARBON	2.2K	5%	1/4W	R905	1-249-427-11	CARBON	6.8K	5%	1/4W
R516	△ 1-217-402-00	FUSIBLE	180	5%	1/4W F	R910	△ 1-212-865-00	FUSIBLE	22	5%	1/4W F
R521	1-249-414-11	CARBON	560	5%	1/4W	R911	1-249-437-11	CARBON	47K	5%	1/4W
R522	1-249-414-11	CARBON	560	5%	1/4W	R921	△ 1-212-889-00	FUSIBLE	220	5%	1/4W F
R523	1-249-418-11	CARBON	1.2K	5%	1/4W	R922	1-249-424-11	CARBON	3.9K	5%	1/4W
R524	1-249-411-11	CARBON	330	5%	1/4W	R931	△ 1-217-497-00	FUSIBLE	220	5%	1W F
R525	1-249-420-11	CARBON	1.8K	5%	1/4W	R932	1-249-425-11	CARBON	4.7K	5%	1/4W
R526	1-249-427-11	CARBON	6.8K	5%	1/4W	R933	1-247-883-00	CARBON	150K	5%	1/4W
R527	1-249-425-11	CARBON	4.7K	5%	1/4W	R934	1-249-440-11	CARBON	82K	5%	1/4W
R528	1-249-417-11	CARBON	1K	5%	1/4W						
R529	1-249-415-11	CARBON	680	5%	1/4W			< VARIABLE RESISTOR >			
R530	1-249-425-11	CARBON	4.7K	5%	1/4W	RV201	1-237-460-11	RES. ADJ. CARBON 20K			
R601	1-249-433-11	CARBON	22K	5%	1/4W	RV202	1-237-460-11	RES. ADJ. CARBON 20K			
R602	1-249-433-11	CARBON	22K	5%	1/4W	RV203	1-237-456-11	RES. ADJ. CARBON 1K			
R603	1-249-433-11	CARBON	22K	5%	1/4W	RV241	1-237-463-11	RES. ADJ. CARBON 200K			
R604	1-249-437-11	CARBON	47K	5%	1/4W	RV251	1-237-459-11	RES. ADJ. CARBON 10K			
R605	1-249-437-11	CARBON	47K	5%	1/4W	RV252	1-237-463-11	RES. ADJ. CARBON 200K			
R606	1-249-437-11	CARBON	47K	5%	1/4W	RV301	1-237-465-11	RES. ADJ. CARBON 1M			
R607	1-249-437-11	CARBON	47K	5%	1/4W	RV302	1-237-465-11	RES. ADJ. CARBON 1M			
R608	1-249-429-11	CARBON	10K	5%	1/4W	RV303	1-237-461-11	RES. ADJ. CARBON 50K			
R609	1-249-429-11	CARBON	10K	5%	1/4W	RV401	1-237-463-11	RES. ADJ. CARBON 200K			
R610	1-249-429-11	CARBON	10K	5%	1/4W	RV402	1-237-461-11	RES. ADJ. CARBON 50K			
R611	1-249-429-11	CARBON	10K	5%	1/4W			< RELAY >			
R612	1-249-429-11	CARBON	10K	5%	1/4W	RY151	1-515-614-11	RELAY			
R613	1-249-429-11	CARBON	10K	5%	1/4W	RY152	1-515-614-11	RELAY			
R614	1-249-437-11	CARBON	47K	5%	1/4W	RY153	1-515-614-11	RELAY			
R615	1-249-429-11	CARBON	10K	5%	1/4W			< THERMISTOR >			
R616	1-249-433-11	CARBON	22K	5%	1/4W	TH201	1-807-970-11	THERMISTOR 150			
R617	1-249-433-11	CARBON	22K	5%	1/4W	TH202	1-808-269-11	THERMISTOR 250			
R618	1-249-433-11	CARBON	22K	5%	1/4W	TH203	1-808-269-11	THERMISTOR 250			
R619	1-249-433-11	CARBON	22K	5%	1/4W	TH271	1-807-972-11	THERMISTOR 1250			
R620	1-249-429-11	CARBON	10K	5%	1/4W			< TERMINAL >			
R621	1-249-429-11	CARBON	10K	5%	1/4W	TM101	1-537-247-11	TERMINAL BOARD (ANT)			
R622	1-249-429-11	CARBON	10K	5%	1/4W			< TEST PIN >			
R623	1-249-429-11	CARBON	10K	5%	1/4W	TP201	* 1-565-513-11	PIN, CONNECTOR 2P			
R624	1-247-895-00	CARBON	470K	5%	1/4W	TP271	* 1-565-513-11	PIN, CONNECTOR 2P			
R625	1-249-433-11	CARBON	22K	5%	1/4W	TP601	* 1-565-513-11	PIN, CONNECTOR 2P			
R626	△ 1-212-873-11	FUSIBLE	47	5%	1/4W F	TP602	* 1-565-513-11	PIN, CONNECTOR 2P			
R627	1-249-417-11	CARBON	1K	5%	1/4W						
R628	1-249-441-11	CARBON	100K	5%	1/4W						
R629	1-247-883-00	CARBON	150K	5%	1/4W						
R630	1-249-433-11	CARBON	22K	5%	1/4W						
R631	1-249-429-11	CARBON	10K	5%	1/4W						
R671	1-249-410-11	CARBON	270	5%	1/4W						

The components identified by mark △ or dotted line with mark △ are critical for safety. Replace only with part number specified.

TUNER

Ref. No.	Part No.	Description	Remark
		< VIBRATOR, CRYSTAL >	
XT501	1-567-826-21	VIBRATOR, CRYSTAL	
XT601	1-577-359-21	VIBRATOR, CERAMIC	

MISCELLANEOUS

5	1-452-419-21	MAGNET	
78	△ 1-559-297-31	CODE, POWER	
79	△ 1-569-007-11	ADAPTER, CONVERSION 2P	
CN671	* 1-599-135-41	CORD (WITH CONNECTOR)	
PT901	△ 1-450-410-11	TRANSFORMER, POWER	
S952	△ 1-572-944-11	SWITCH, POWER VOLTAGE SELECTION	

ACCESSORIES & PACKING MATERIALS

1-417-141-11	MATCHING TRANSFORMER, ANTENNA
1-501-224-00	ANTENNA, FEEDER
1-501-451-11	ANTENNA, LOOP
1-558-233-11	CORD (WITH CONNECTOR) (SIRCS) 4P
1-559-533-11	CORD, CONNECTION
3-704-366-01	SCREW (CASE) (M3X8)
3-753-233-11	MANUAL, INSTRUCTION (ENGLISH, FRENCH, SPANISH, ITALIAN)
* 4-923-472-01	CUSHION
* 4-926-824-41	INDIVIDUAL CARTON

HARDWARE LIST

#1	7-682-547-09	SCREW +BV 3X6, S TIGHT
#2	7-682-548-09	SCREW +B 3X8
#3	7-682-549-09	SCREW +BVTT 3X10 (S)
#4	7-682-560-09	SCREW +BVTT 4X6 (S)
#5	7-685-134-19	SCREW +P 2.6X8 TYPE2 NON-SLIT
#6	7-685-883-09	SCREW +BVTT 4X12 (S)

The components identified by mark △ or dotted line with mark △ are critical for safety. Replace only with part number specified.

