

MITSUBISHI (AV COMMON) M5218AL/P/FP

DUAL LOW-NOISE OPERATIONAL AMPLIFIERS (DUAL POWER SUPPLY TYPE)

DESCRIPTION

The M5218 are semiconductor integrated circuits designed for a low noise preamplifier in audio equipment and a general-purpose operational amplifier in other electronic equipment. Two low noise operational amplifier circuits displaying internal phase-compensated high gain and low distortion are contained in an 8-pin SIP, DIP or FP for application over a wide range as a general-purpose dual amplifier in general electronic equipment.

The devices have virtually the same characteristics as the 4557, 4558, 4559 and 741 operational amplifiers.

The units can also be used as a single power supply type and amplifier in portable equipment. It is also suitable as a headphone amplifier because of its high load current.

FEATURES

- High gain, low distortion
..... $G_{VO}=110\text{dB}$, $T_{HE}=0.0015\%$ (typ.)
- High slew rate, high f_T
..... $SR=3.0\text{V}/\mu\text{s}$, $f_T=7\text{MHz}$ (typ.)
- Low noise ($R_S=1\text{k}\Omega$) FLAT $V_{NI}=2\mu\text{Vrms}$ (typ.)
RIAA $V_{NI}=1\mu\text{Vrms}$ (typ.)
- Operation with low supply voltage
..... $V_{CC}\geq 4\text{V}(\pm 2\text{V})$
- High load current, high power dissipation
..... $I_{LP}=\pm 50\text{mA}$, $P_d=800\text{mW}$ (SIP)
 $P_d=625\text{mW}$ (DIP), $P_d=440\text{mW}$ (FP)

APPLICATION

General-purpose amplifier in stereo equipment, tape decks, and radio stereo cassette recorders; active filters, servo amplifiers, operational circuits in other general electronic equipment.

RECOMMENDED OPERATING CONDITIONS

- Supply voltage range $\pm 2 \sim \pm 16\text{V}$
- Rated supply voltage $\pm 15\text{V}$

PIN CONFIGURATION (TOP VIEW)

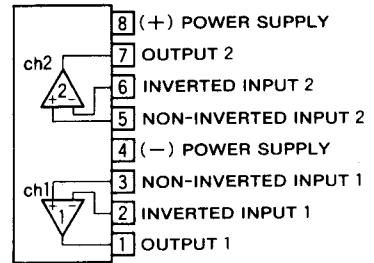

Outline 8P5 (AL)

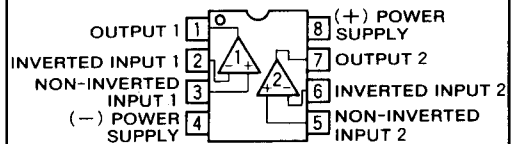

Outline 8P4 (AP)
8P2S-A (AFP)

BLOCK DIAGRAM

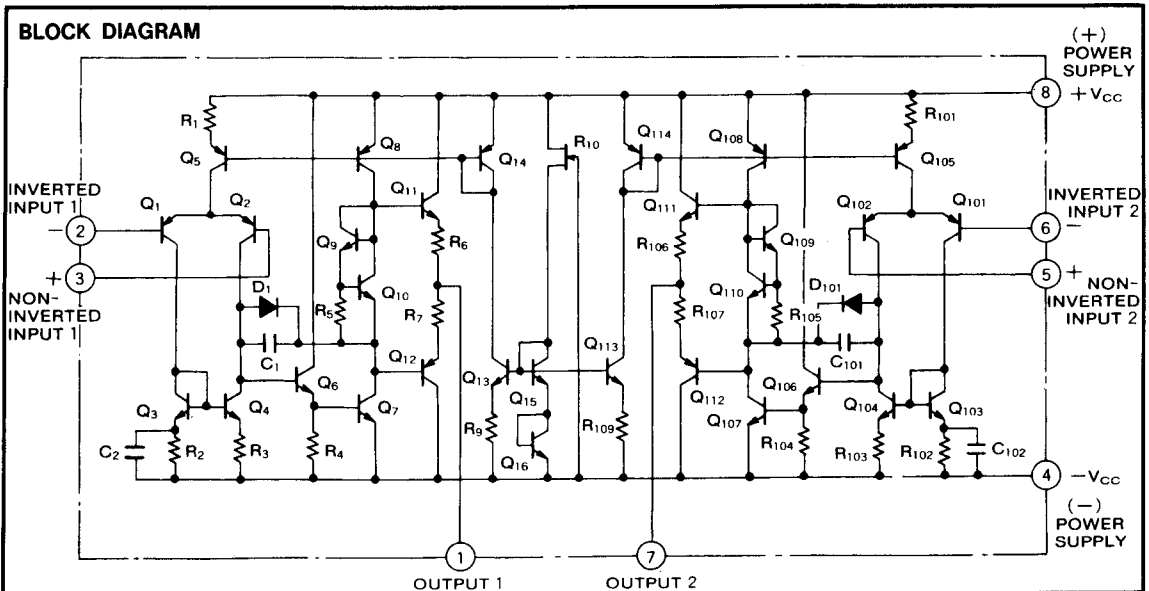

DUAL LOW-NOISE OPERATIONAL AMPLIFIERS (DUAL POWER SUPPLY TYPE)

ABSOLUTE MAXIMUM RATINGS ($T_a=25^\circ\text{C}$, unless otherwise noted)

Symbol	Parameter	Conditions	Ratings	Unit
V_{CC}	Supply voltage		± 18	V
I_{LP}	Load current		± 50	mA
V_{id}	Differential input voltage		± 30	V
V_{ic}	Common input voltage		± 15	V
P_d	Power dissipation		800(SIP)/625(DIP)/440(FP)	mW
K_θ	Thermal dirating	$T_a \geq 25^\circ\text{C}$	8(SIP)/6.25(DIP)/4.4(FP)	mW/°C
T_{opr}	Ambient temperature		$-20 \sim +75$	°C
T_{stg}	Storage temperature		$-55 \sim +125$	°C

ELECTRICAL CHARACTERISTICS ($T_a=25^\circ\text{C}$, $V_{CC}=\pm 15\text{V}$)

Symbol	Parameter	Test conditions	Limits			Unit
			Min.	Typ.	Max.	
I_{CC}	Circuit current	$V_{in}=0$		3.0	6.0	mA
V_{IO}	Input offset voltage	$R_S \leq 10\text{k}\Omega$		0.5	6.0	mV
I_{IO}	Input offset current			5	200	nA
I_{IB}	Input bias current				500	nA
R_{in}	Input resistance		0.3	5		MΩ
G_{VO}	Open loop voltage gain	$R_L \geq 2\text{k}\Omega, V_o = \pm 10\text{V}$	86	110		dB
V_{OM}	Maximum output voltage	$R_L \geq 10\text{k}\Omega$	± 12	± 14		V
		$R_L \geq 2\text{k}\Omega$	± 10	± 13		
V_{CM}	Common input voltage range		± 12	± 14		V
CMRR	Common mode rejection ratio	$R_S \leq 10\text{k}\Omega$	70	90		dB
SVRR	Sypply voltage	$R_S \leq 10\text{k}\Omega$		30	150	$\mu\text{V}/\text{V}$
P_d	Power dissipation		90	180		mW
SR	Slew rate	$G_v=0\text{dB}, R_L=2\text{k}\Omega$		3.0		V/ μs
f_T	Gain bandwidth product			7		MHz
V_{NI}	input referred noise voltage	$R_S=1\text{k}\Omega, \text{BW}:10\text{Hz}\sim 30\text{kHz}$		2.0		μVrms

TYPICAL CHARACTERISTICS

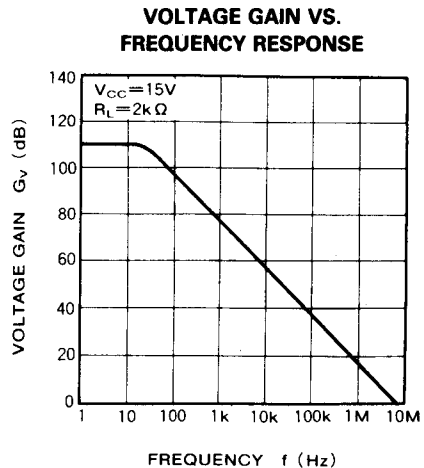
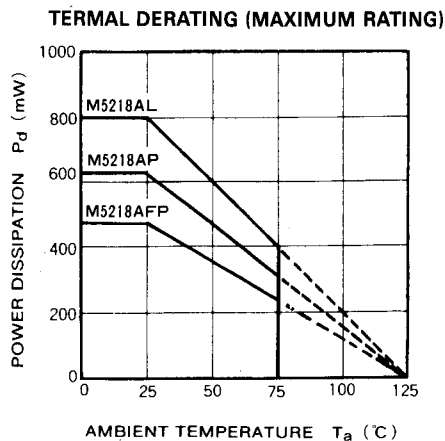

DUAL LOW-NOISE OPERATIONAL AMPLIFIERS (DUAL POWER SUPPLY TYPE)

CIRCUIT CURRENT VS. SUPPLY VOLTAGE

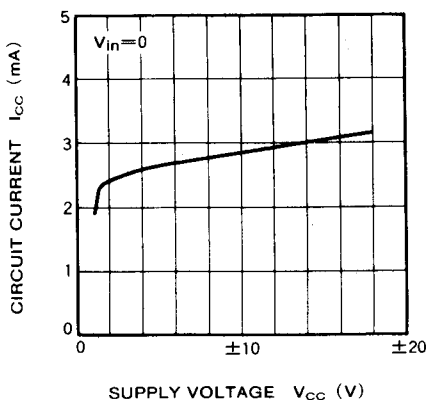

CIRCUIT CURRENT VS. AMBIENT TEMPERATURE

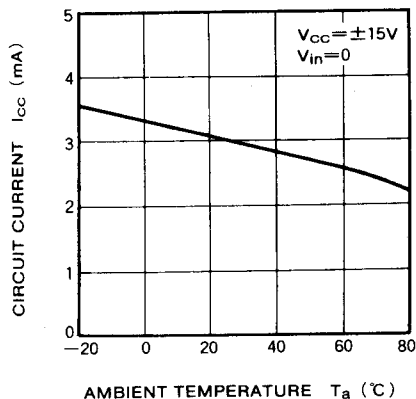

INPUT OFFSET VOLTAGE VS. AMBIENT TEMPERATURE

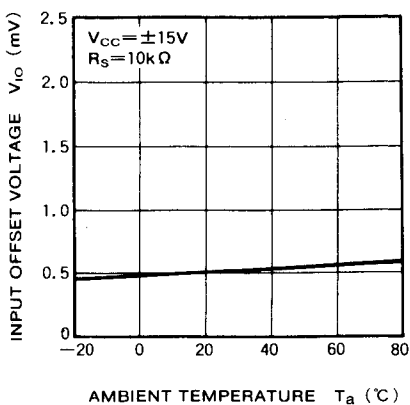

OUTPUT VOLTAGE / LOAD CURRENT PEAK VS. LOAD RESISTANCE

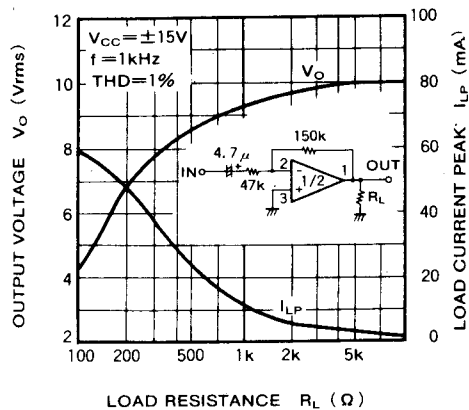

MAXIMUM OUTPUT VOLTAGE VS. SUPPLY VOLTAGE

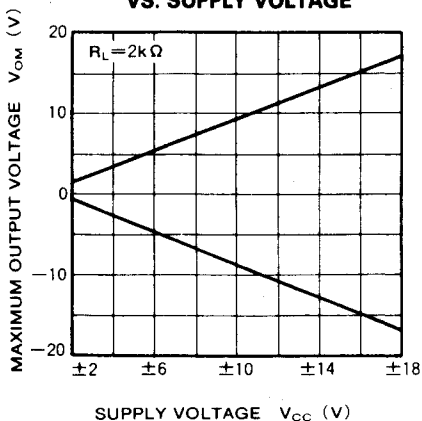

MAXIMUM OUTPUT VOLTAGE VS. FREQUENCY RESPONSE

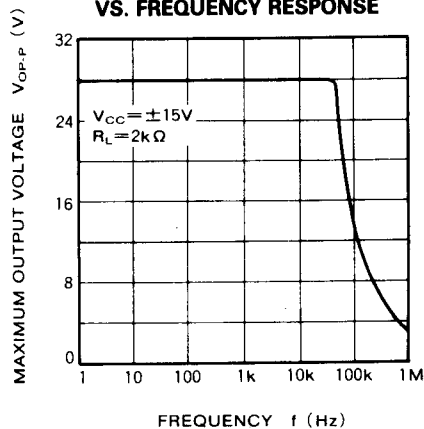

DUAL LOW-NOISE OPERATIONAL AMPLIFIERS (DUAL POWER SUPPLY TYPE)

APPLICATION EXAMPLES

(1) Stereo Equalizer amplifier circuit

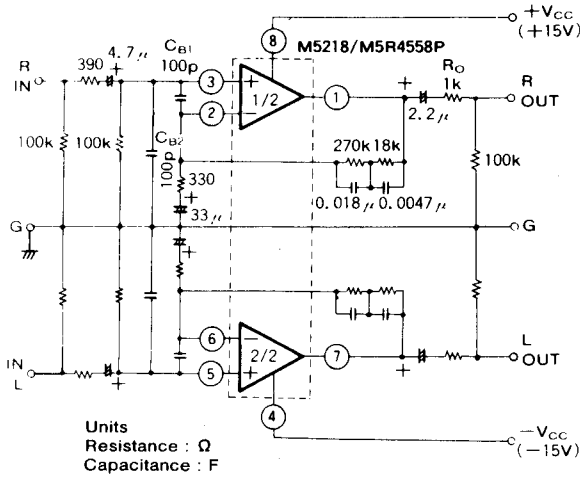

Left channel circuit constants are identical to those of right channel.
 C_{B1} , C_{B2} : Capacitors for buzz prevention, use if required.
 R_O : Resistor used to prevent parasitic oscillation for capacitive loads and current limiting with shorted and other abnormal load conditions.

TYPICAL CHARACTERISTICS ($V_{CC} = \pm 15V$, RIAA)

- $G_V = 35.6\text{dB}$ ($f = 1\text{kHz}$)
- $V_{NI} = 1\ \mu\text{Vrms}$ ($R_S = 1\text{k}\Omega$, $BW = 20\text{Hz} \sim 30\text{kHz}$)
- Signal-to-noise = 72.5dB (IHF-A network, shorted input, 2.5mVrms input sensitivity)
- THD = 0.0015% ($f = 1\text{kHz}$, $V_O = 3\text{Vrms}$)

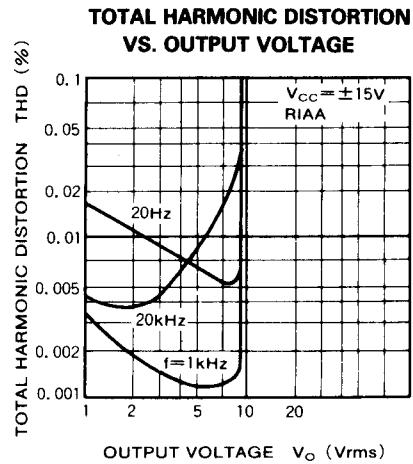

OUTPUT NOISE VOLTAGE VS. SIGNAL SOURCE RESISTANCE

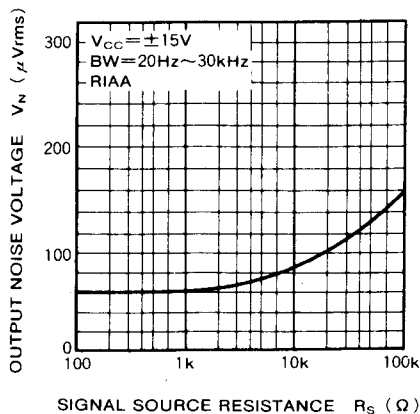

SIGNAL-TO-NOISE RATIO VS. SIGNAL SOURCE RESISTANCE

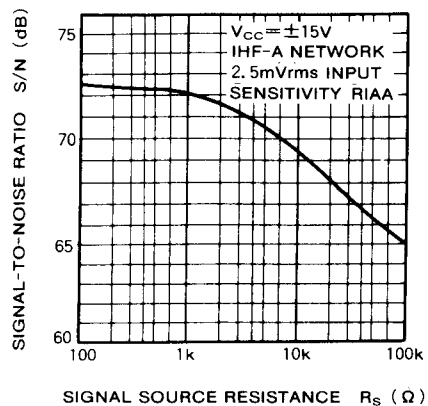

DUAL LOW-NOISE OPERATIONAL AMPLIFIERS (DUAL POWER SUPPLY TYPE)

(2) High S / N stereo DC ICL equalizer

TYPICAL CHARACTERISTICS ($V_{CC} = \pm 15V$, RIAA)

- Signal-to-noise = 72.5dB (IHF-A network, shorted input, 2.5mVrms input sensitivity)
- $V_{NI} = 0.77 \mu V_{rms}$ ($R_S = 5.1k\Omega$, BW = 5Hz ~ 100kHz)
- $G_V = 35.6dB$ ($f = 1kHz$)

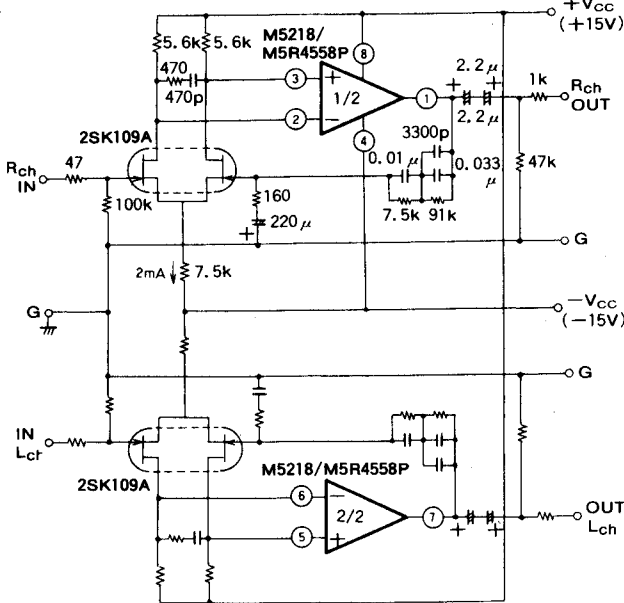

TOTAL HARMONIC DISTORTION VS. OUTPUT VOLTAGE

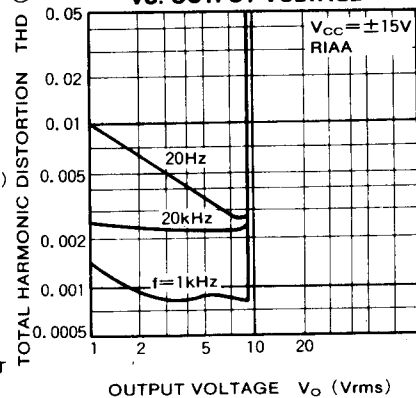

Left channel circuit constants are identical to those of right channel.

Units Resistance : Ω
Capacitance : F

(3) Headphone amplifier

TOTAL HARMONIC DISTORTION VS. OUTPUT VOLTAGE

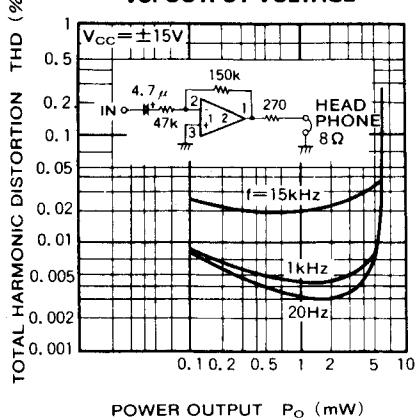

(Output resistance R_O is made the parameter) POWER OUTPUT / POWER DISSIPATION VS. SUPPLY VOLTAGE

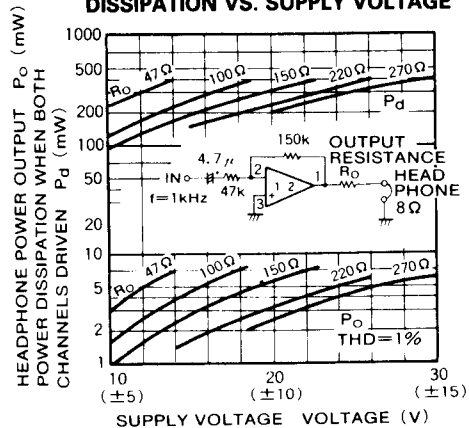

8P2S-A

Plastic 8pin 225mil SOP

EIAJ Package Code	JEDEC Code	Weight(g)	Lead Material
SOP8-P-225-1.27	-	0.07	Cu Alloy

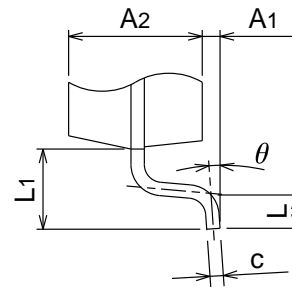
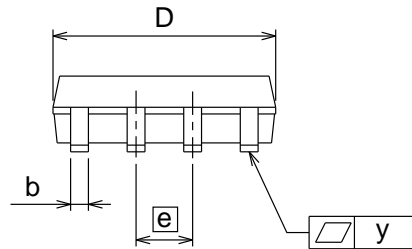
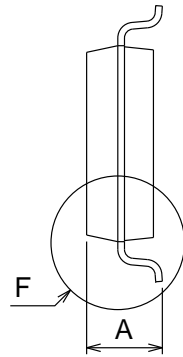
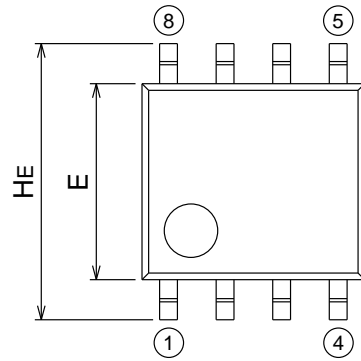

Detail F

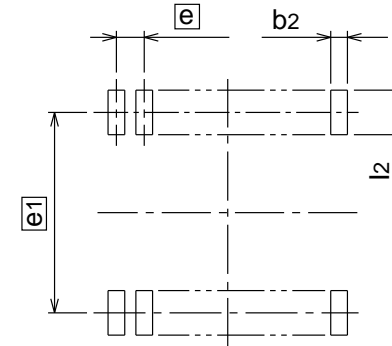

Recommended Mount Pad

Symbol	Dimension in Millimeters		
	Min	Nom	Max
A	-	-	1.9
A1	0.05	-	-
A2	-	1.5	-
b	0.35	0.4	0.5
c	0.13	0.15	0.2
D	4.8	5.0	5.2
E	4.2	4.4	4.6
e	-	1.27	-
HE	5.9	6.2	6.5
L	0.2	0.4	0.6
L1	-	0.9	-
y	-	-	0.1
θ	0°	-	10°
b2	-	0.76	-
e1	-	5.72	-
l2	1.27	-	-