



LA3410

VCO Non-Adjusting PLL FM MPX Stereo Demodulator with FM Accessories

Overview

The LA3410 is a multiplex demodulator IC designed for FM stereo tuner. It features the VCO non-adjusting function that eliminates the need to adjust the free-running frequency of VCO.

Applications

- Home stereos, portable hi-fi sets.

Functions

- VCO non-adjusting function.
- PLL MPX stereo demodulator.
- Gain variable type post amplifier.
- VCO stop function.
- Separation adjust function.

Features

- Non-adjusting VCO : Eliminates the need to adjust the free-running frequency.
- Good temperature characteristic of VCO : $\pm 0.1\%$ typ. for $\pm 50^\circ\text{C}$ change.
- Low distortion at high frequencies in stereo main channel (0.06% at $f=10\text{kHz}$) (Non-adjusting PLL makes the capture range narrower, leading to improvement in beat distortion at high frequencies in stereo main channel.)
- Low distortion : 1kHz 300mV input mono 0.025% typ. main 0.02% typ.
- High S/N : 91dB typ. (mono 300mV input, LPF). 92dB typ. (mono 300mV input, IHF BPF).
- High voltage gain : Approximately 8.5dB (at standard constants).
- Wide dynamic range : Distortion 1.0% at mono 800mV, 1kHz input.
- Good ripple rejection of power supply : 34dB typ.

Package Dimensions

unit:mm

3006B-DIP16

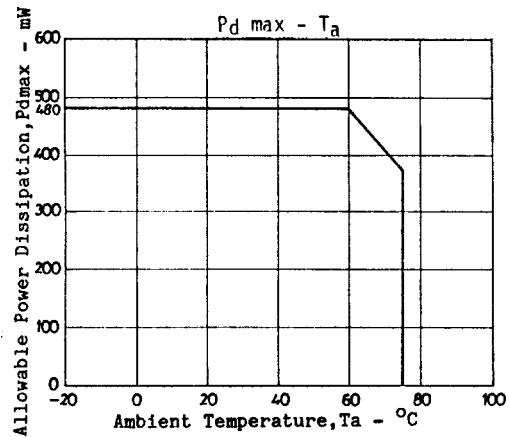
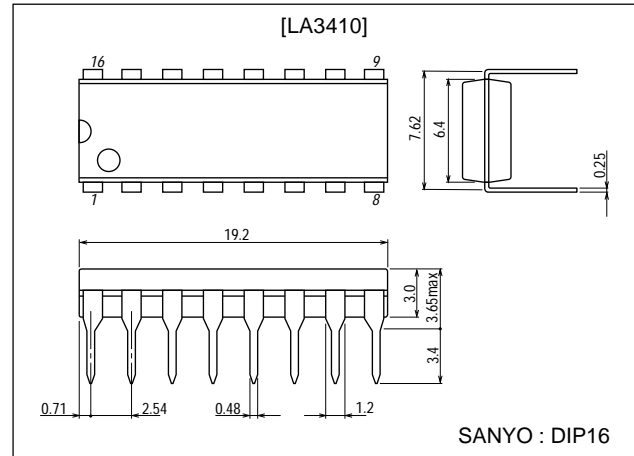

■ Any and all SANYO products described or contained herein do not have specifications that can handle applications that require extremely high levels of reliability, such as life-support systems, aircraft's control systems, or other applications whose failure can be reasonably expected to result in serious physical and/or material damage. Consult with your SANYO representative nearest you before using any SANYO products described or contained herein in such applications.

■ SANYO assumes no responsibility for equipment failures that result from using products at values that exceed, even momentarily, rated values (such as maximum ratings, operating condition ranges, or other parameters) listed in products specifications of any and all SANYO products described or contained herein.

SANYO Electric Co., Ltd. Semiconductor Company

TOKYO OFFICE Tokyo Bldg., 1-10, 1 Chome, Ueno, Taito-ku, TOKYO, 110-8534 JAPAN

LA3410

Specifications

Absolute Maximum Ratings at $T_a = 25^\circ\text{C}$

Parameter	Symbol	Conditions	Ratings	Unit
Maximum Supply Voltage	$V_{CC\text{ max}}$		16	V
Lamp Driving Current	$I_L\text{ max}$		30	mA
Allowable Power Dissipation	$P_d\text{ max}$	$T_a \leq 60^\circ\text{C}$	480	mW
Operating Temperature	T_{opr}		-20 to +75	$^\circ\text{C}$
Storage Temperature	T_{stg}		-40 to +125	$^\circ\text{C}$

Operating Conditions at $T_a = 25^\circ\text{C}$

Parameter	Symbol	Conditions	Ratings	Unit
Recommended Supply Voltage	V_{CC}		12	V
Operating Voltage Range	$V_{CC\text{ op}}$		6.5 to 14	V
Recommended Input Signal Voltage	V_i		300	mV

Operating Characteristics at $T_a = 25^\circ\text{C}$, $V_{CC}=12\text{V}$, $V_i=300\text{mV}$, $f=1\text{kHz}$, $L+R=90\%$, $\text{pilot}=10\%$

Parameter	Symbol	Conditions	Ratings			Unit
			min	typ	max	
Quiescent Current	I_{cco}	Quiescent		18.5	28	mA
Input Resistance	r_i			20		$k\Omega$
Ripple Rejection of Power Supply				34		dB
Channel Separation	Sep	$f=100\text{Hz}$		45		dB
		$f=1\text{kHz}$	40	55		dB
		$f=10\text{kHz}$		42		dB
Total Harmonic Distortion	THD	mono		0.025	0.15	%
		main $f=100\text{Hz}$		0.02		%
		main $f=1\text{kHz}$		0.02	0.15	%
		main $f=10\text{kHz}$		0.06		%
		sub		0.02	0.15	%
Allowable Input Level	$V_i\text{ max}$	THD=1%, mono	700	800		mV
Signal-to-Noise Ratio	S/N	mono, $R_g=5.1k\Omega$, LPF	80	91		dB
		mono, $R_g=5.1k\Omega$, IHF BPF		92		dB
Lamp Lighting Level	V_L	Pilot level	4	8	17	mV
Lamp Hysteresis	H_y			3		dB
Capture Range				+0.8		%
				-1.2		%
Output Voltage	V_o	mono (Note 1)	500	730	1000	mV
Channel Balance	CB	mono			1	dB
Carrier Leak				31		dB
VCO Stop Voltage			5.5		$V_{CC}-3$	V

Note 1 : The output voltage on pin 4 or 7 is measured after separation adjust.

LA3410

Equivalent Circuit Block Diagram and Sample Application Circuit

* : Use a nonpolarized electrolytic capacitor or polyester film capacitor in the VCO stop mode. If a polarized electrolytic capacitor is used, refer to "VCO Stop Method" shown below.

X : Murata CSB456F11
Kyocera KBR-457HS
LPF L BL-13 (Korin Giken)

Note 1 :
Set the PLL loop filter constants (R8, C9, C10), with the input pilot level considered, so that the capture range becomes wide. (Refer to No. 4 or Proper Cares in Using IC.)

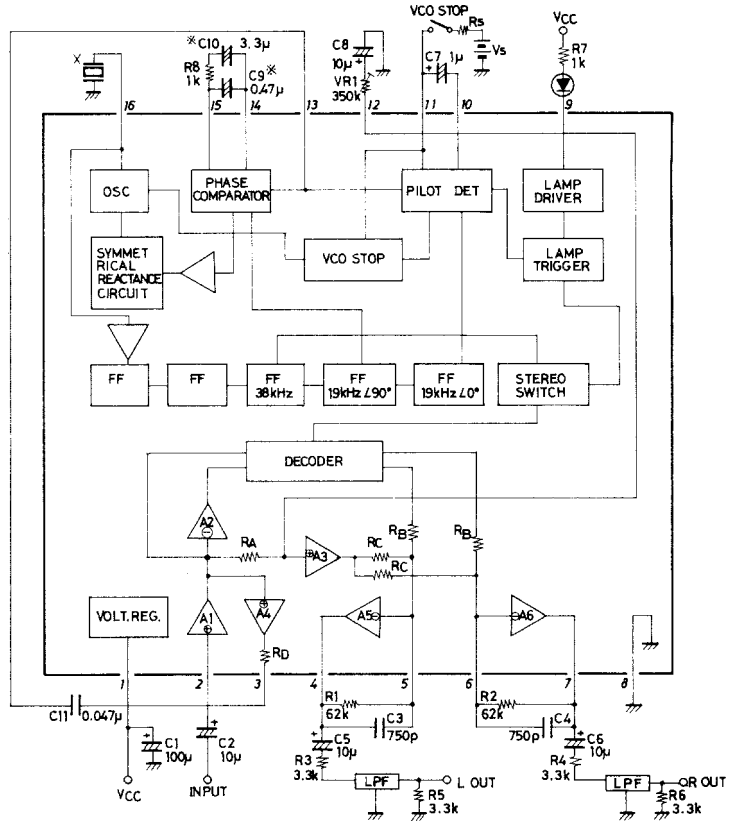

Unit (resistance : Ω , capacitance : F)

Sample Printed Circuit Pattern

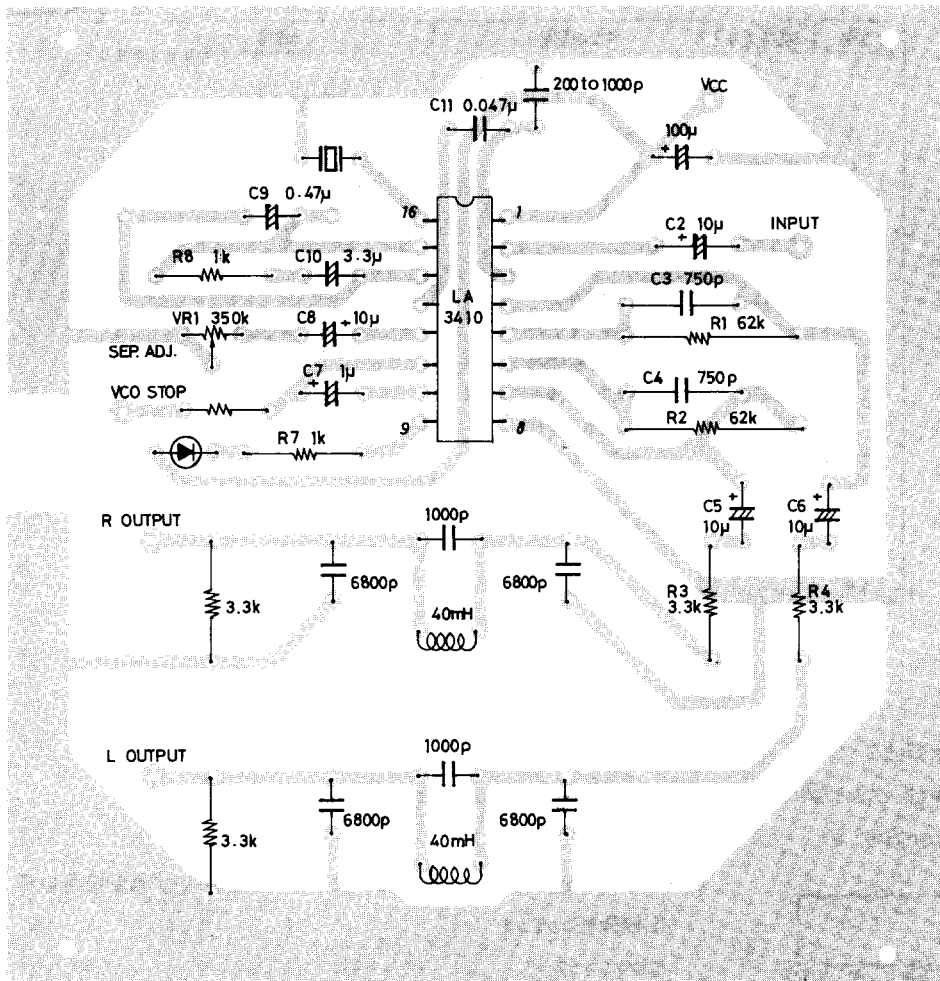

80 x 80.25 mm²
Cu-foiled area

External Parts

	Symbol	Kind	Element Value	Remarks
Capacitor	C1	Electrolytic capacitor	100 μ F	Power supply ripple filter
	C2	Electrolytic capacitor	10 μ F	DC cut
	C3 to 4	Ceramic capacitor	750pF	De-emphasis constant R1C3=R2C4=50 μ s, 75 μ s
	C5 to 6	Electrolytic capacitor	10 μ F	DC cut
	C7	Electrolytic capacitor	1 μ F	Sync detect filter
	C8	Electrolytic capacitor	10 μ F	DC cut
	C9	Non-polarized capacitor	0.47 μ F	Loop filter Note 1
	C10	Non-polarized capacitor	3.3 μ F	Loop filter Note 1
Resistor	R1 to 2	Carbon film resistor	62k Ω	De-emphasis constant, post amplifier feedback resistor
	R3 to 6	Carbon film resistor	3.3k Ω	LPF input/output resistor
	R7	Carbon film resistor	1k Ω	Lamp current limiting
	R8	Carbon film resistor	1k Ω	Loop filter
Semifixed Resistor	V _{R1}	Carbon film resistor	350k Ω	Separation adjust
Resonator	X	Ceramic resonator	CSB456F11 KBR457HS	Murata Kyocera

Note 1 : IF C9, C10 are polarized capacitors, refer to “VCO Stop Method ②” shown below

Note 2 : For loop filter constants (C9, C10, R8), refer to 4. Capture range and PLL loop filter constants on page 5 and set these constants to the optimum values for the input pilot level.

Voltage on Each Pin and Pin Name

Pin No.	Voltage [V]	Pin Name	Remarks
1	V _{CC}	Power supply	
2	3.0V	MPX input	Input resistance 20k Ω
3	3.0V	Composite amplifier output	Output resistance 1k Ω
4	3.0V	Post amplifier output	L output
5	3.0V	Post amplifier input	Minus input
6	3.0V	Post amplifier input	Minus input
7	3.0V	Post amplifier output	R output
8	0	GND	
9	-	Stereo indicator	I _L max=30mA
10	2.7V	Pilot sync detect filter	
11	2.7V	Pilot sync detect filter VCP stop	
12	3.0V	Separation adjust	
13	2.7V	PLL input	
14	2.7V	PLL loop filter	
15	2.7V	PLL loop filter	
16	-	OSC	

Proper Cares in Using IC

1. VCO stop method

One of the following is used to stop VCO. The monaural mode is forced to be entered at the time of VCO stop.

(1) VCO stop method ①

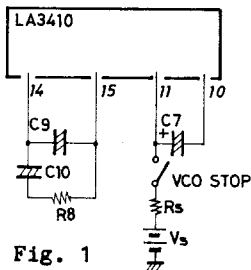

Fig. 1

(a) For loop filter capacitors (C9, C10 in Fig. 1), use one of the following.

- (1) Non-polarized capacitor
- (2) Polyester film capacitor

[Reason] When in the VCO stop mode, external voltage V_S causes an unpolarized voltage of approximately 1.5V to be developed across pins 14 and 15.

(b) Setting of external voltage V_S and limiting resistor R_S.

The relation between V_S and R_S is shown in Fig. 9. When in the VCO stop mode, the value of R_S must be set so that the voltage on pin 11 is within the specified range (min=5.5V, max=V_{CC}-3V). For example, it is seen from Fig. 9 that the value of limiting resistor R_S is approximately 4.2k Ω when the voltage on pin 11 is set to 6V at V_S=12V.

(2) VCO stop method ②

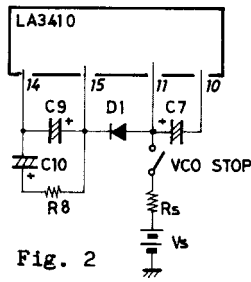

Fig. 2

(a) Addition of diode (small-signal silicon diode)

Diode D1 is additionally connected across pins 11 and 15 as shown in Fig. 2. In this case, the use of nonpolarized capacitors for C9, C10 across pins 14 and 15 involves no problem (pin 15 : + polarity).

(Note) When D1 is connected across pins 11 and 14, stereo start time may be 2 to 3 seconds late as compared with the application in Fig. 2.

(b) Setting of external voltage V_S and limiting resistor R_S .

The relation between V_S and R_S is shown in Fig. 10. When in the VCO stop mode, the value of R_S must be set so that the voltage on pin 11 is within the specified range (min=5.5V, max= $V_{CC}-3V$). For example, it is seen from Fig.10 that the value of limiting resistor R_S is approximately 2.2k Ω when the voltage on pin 11 is set to 6V at $V_S=12V$.

2. Checking of free-running frequency

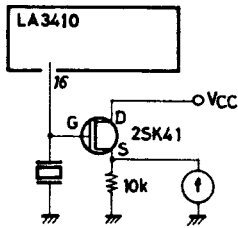

Fig. 3

Since no pin is provided for checking the free-running frequency, the free-running frequency is checked through a buffer amplifier with a high input impedance, low input capacitance connected to pin 16. Fig. 3 shows a sample circuit configuration. The frequency measured in this circuit configuration is 456kHz or thereabouts. The frequency in 19kHz equivalent can be obtained by dividing this measured value by 24. The wiring across pin 16 and the buffer amplifier input must be made as short as possible (within 1cm).

3. Ceramic resonator

Ceramic resonators other than specified cannot be used in applications of the LA3410. The Type No., manufacturer of the ceramic resonators specified are shown below. For particulars about the ceramic resonator, contact the manufacturer.

Type No.	Manufacturer
CSB456F11	Murata
KBR-457HS	Kyocera

4. Capture range and PLL loop filter constants

(1) Definition of capture range

Since the VCO of the LA3410 is adjustment-free, the capture range is defined by the following formula with the deviation of the free-running frequency from the pilot signal considered.

$$\text{Capture range C. R} = \left(\frac{F_0 - F_1}{F_1} - \frac{F_0 - 456}{456} \right) \times 100 [\%]$$

F_0 : Free-running frequency

F_1 : Lock frequency when the input frequency is varied

(2) PLL loop filter constants

(a) The capture range of the LA3410 depends primarily on input pilot level and PLL loop filter constants C9 and R8 as shown in Fig. 4-A.

It is necessary to set C9 and R8, with the input pilot level considered, so that the capture range becomes wide but the stereo distortion is kept rather low. The transfer function of the loop filter is given by :

$$\text{Lag filter } F(S) = \frac{1}{SC9R0+1}$$

$$\text{Lag Lead filter } F(S) = \frac{SC10R8+1}{SC10(R0+R8)+1}$$

R0 : IC internal resistance and the response is given by Fig.4-B. The capture range may be made wide by the following methods.

- ① Set 3 high to make the band width wide (Decrease C9).
- ② Increase the high frequency gain F(∞) so long as the characteristic of the Lag Lead filter is not lost (Increases R8).

Fig. 4-C shows the capture range characteristic when C9 and R8 are varied. When R8 is increased, the capture range will increase to a certain point. R8 must be set in this range. When R8 is increased, the STEREO-L, R distortion may worsen at low frequencies (100 to 400Hz). In this case, connect a capacitor of 200 to 1000pF across pin 3 and GND to improve the STEREO-L, R distortion (Refer to Fig. 5).

(3) Fig. 4-D shows the capture range characteristic when C10 is varied. The adequate value of C10, which depends on C9 and R8, is 0.33 to 3.3μF. If the value of C10 is decreased too much, the capture range will decrease as seen from Fig. 3 ; and if increased too much, the stereo start time after VCO STOP release will be made late.

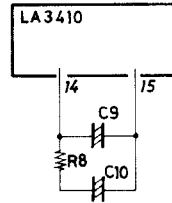
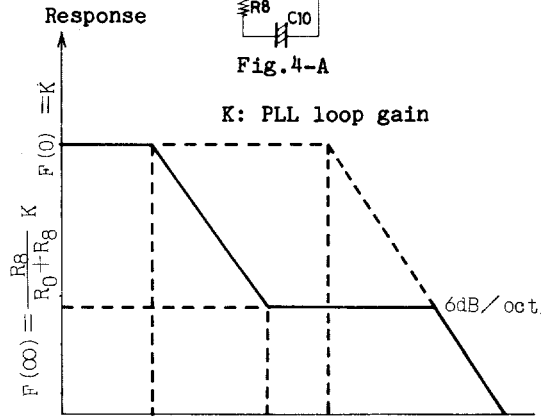

Fig. 4-A



$$\omega_1 = \frac{1}{C_{10}(R_0+R_8)} \quad \omega_2 = \frac{1}{C_{10}R_8} \quad \omega_3 = \frac{1}{C_9R_0}$$

ω_1, ω_2 : Approximate equation at $R_0 \gg R_8$

Fig.4-B

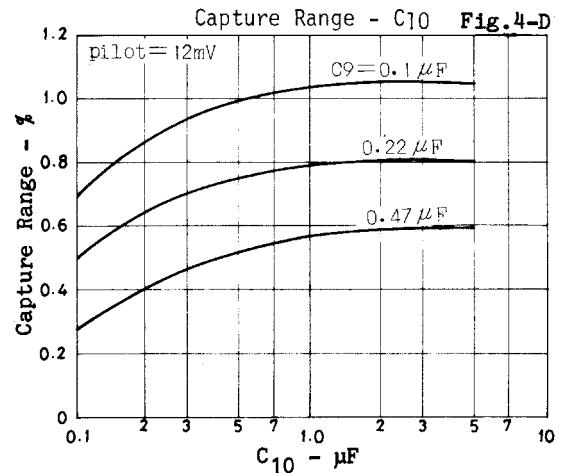
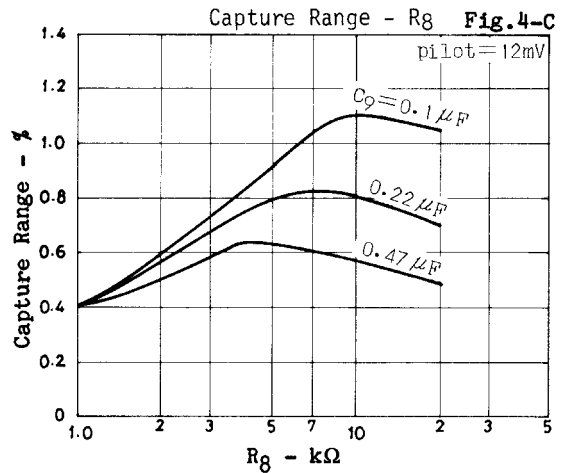

(4) When C9 is decreased, the capture range will widen but the stereo main distortion at f=10kHz will worsen (beat distortion). This data is shown in Fig. 4-E. Set C2 so that the stereo distortion is kept rather low.

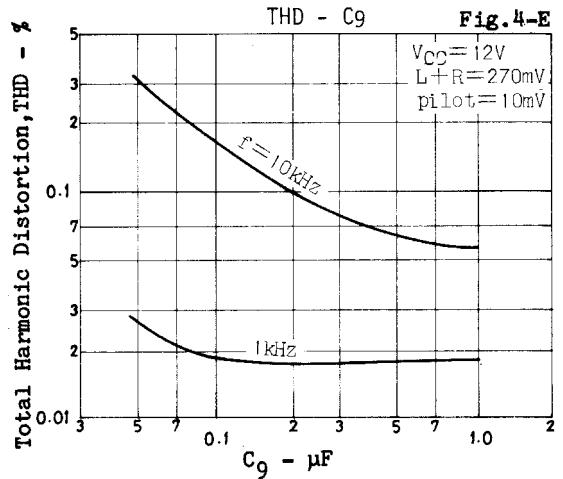

(5) The data on pilot level vs. capture range is shown in Fig. 4-F to G. It is necessary to set the loop filter constants, with the input pilot level considered, so that the capture range becomes wide. For example, when the LA1260 is used for IF IC, the minimum demodulation output will be 183mV (100% mod) and the stereo operation must be performed at pilot level 12mV with a pilot margin allowed. In this case, C2=0.1μF, R1=6.8 to 10kΩ are recommended.

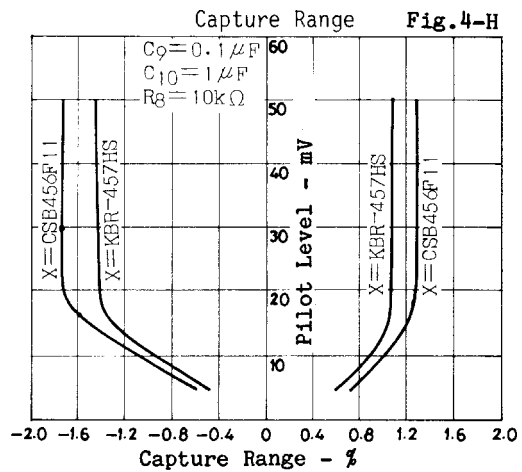
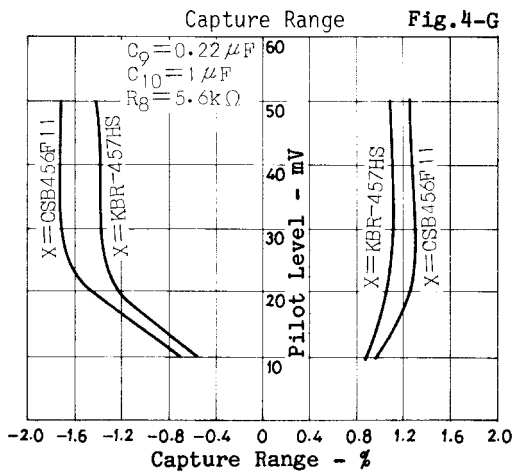
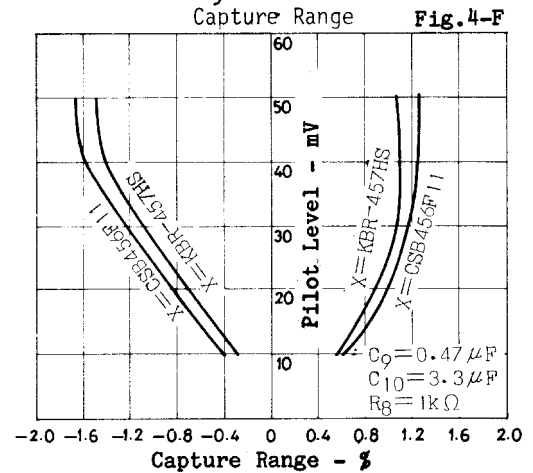

5. Improvement in sub, stereo (R) distortions worsened at low frequencies. There are some cases where the sub, stereo (R) distortions are worsened at low frequencies. One cause for this worsening is the phase shift between 38kHz and 19kHz in the flip-flop inside the IC. This shift is improved by connecting a phase compensating capacitor across pin 3 and GND as shown in Fig. 5. The CD value differs with each IF (the phase shift between the sub signal and pilot signal in the composite signal differs with each IF). An adequate value is 200 to 1500pF.

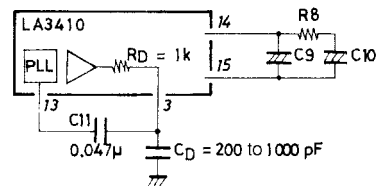

Unit (resistance : Ω, capacitance : F)

6. Separation adjust

The separation is adjusted by varying the main signal level in the composite signal. The main signal is applied to the post amplifier input through amplifiers A1, A3. The input level in A3 is varied by internal resistor RA and external variable resistor VR1. Therefore, the output main signal becomes 0 at VR1=0 and is maximized at VR1=∞. The separation is pre-settable if VR1 is set to an adequate value. In this case, the VR1 value differs with each set; X of VR1 is approximately 150kΩ when the ratio of the main signal and sub signal at the LA3410 input is 1 : 1 and the sub signal and pilot signal are in phase. The separation, when preset, varies 30dB min. with the variations in the IC only considered. If the value of capacitor C8 for DC cut is decreased, the separation gets worse at low frequencies.

7. Post amplifier oscillation when loaded capacitively (inductively)

If the post amplifier outputs (pins 4, 7) are loaded capacitively (inductively), oscillation may occur. When connecting a low-pass filter to each of the outputs, an input resistor must be connected across the post amplifier output and the low-pass filter and the wiring across these points must be made as short as possible.

8. Forced monaural mode

The following method is used to provide the forced monaural mode. In this case, VCO oscillation does not stop. The above-mentioned VCO stop method is used to stop VCO oscillation.

- Connect pin 10 to GND through a resistor of 10kΩ.

Other application circuit

1. How to improve the dynamic range of the post amplifier

The amplifier bias voltage is set low (3.0V) so that the LA3410 is capable of being operated from low voltage. If the supply voltage is high, the following method can be used to extend the dynamic range.

Fig. 6 shows how to extend the dynamic range of the post amplifier. When RB is not used, the DC voltage across pins 4 and 7 is 3.0V. The DC voltage across pins 4 and 7 can be increased to extend the dynamic range of the post amplifier.

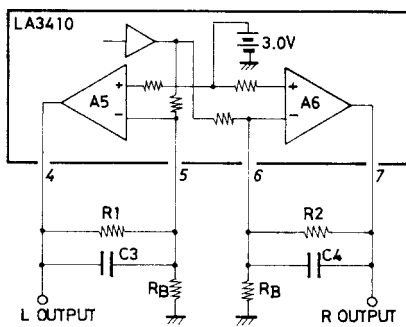

Fig. 6

Pins 5, 6, being minus input pins of the post amplifier, are virtual GND points. By connecting RB across pin 5 and GND and across pin 6 and GND, the DC voltages on pins 4, 7 are obtained as follows :

$$3.0 \frac{R_B + R_1}{R_B} = 3.0 \left(1 + \frac{R_1}{R_B} \right)$$

$$3.0 \frac{R_B + R_2}{R_B} = 3.0 \left(1 + \frac{R_2}{R_B} \right)$$

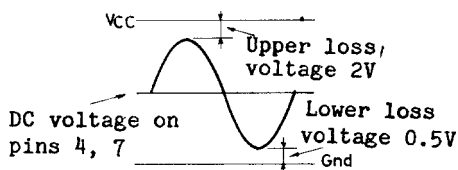

Fig. 7

The upper and lower loss voltages of the post amplifier are approximately 2V and 0.5V respectively. With these loss voltages considered, the voltages on pins 4, 7 are set. For example, Figs. 11, 12 show how the dynamic range is improved when the DC voltages on pins 4, 7 are set to approximately 5.2V with upper loss voltage 2V and lower loss voltage 0.5V of the post amplifier considered. Fig. 11 shows the characteristic where no RB is connected ; Fig. 12 shows the characteristic where RB=82kΩ is connected.

2. Feedback resistance of post amplifier and total gain

Table 2 shows the feedback resistance of the post amplifier and the total gain. Fig. 13 shows the distortion vs. feedback resistance characteristic. Figs. 14, 15 show the sample application circuits where R1 (R2) is 100kΩ and 130kΩ respectively.

R1 (R2)kΩ	C3 (C4)pF	Total gain [dB]	Output signal voltage typ [mV]
62	750	8.5	730
82	620	11	965
100	510	13	1177
130	390	15	1530
150	330	16	1766
180	270	17.5	2119

Table 2. R1 (R2), C3 (C4) – gain

LA3410

Decoder circuit (Refer to the Block Diagram in the Sample Application Circuit.)

The LA3410 adopts a decoder circuit of chopper type. The sub signal sync-detected by this decoder is applied to the post amplifier minus input through R_B as shown in the Sample Application Circuit. This signal is matrixed with the main signal coming out of A3. The demodulation method is, in a sense, a combination of switching method and matrix method. The gain for the sub signal is :

$$V_S \frac{R_1}{R_B} \cdot \frac{2}{\pi} \quad \text{or} \quad V_S \frac{R_2}{R_B} \cdot \frac{2}{\pi}$$

R_1, R_2 : Post amplifier feedback resistor

V_S : Peak value of input sub signal

The gain for the main signal is :

$$V_M \frac{VR1}{R_A+VR1} \cdot \frac{R1}{R_C} \quad \text{or} \quad V_M \frac{VR1}{R_A+VR1} \cdot \frac{R2}{R_C}$$

$VR1$: Semifixed resistor for separation adjust

V_M : Peak value of input main signal

In the LA3410, the gain of the main signal is varied with $VR1$ to adjust the separation. The IF output is generally such that the sub signal level is lower than the main signal level. In this case also, the separation can be adjusted.

3. De-emphasis

The de-emphasis characteristic depends on the feedback resistors, capacitors of the post amplifier. R_1, R_2, C_3, C_4 in the Sample Application Circuit are set as $R_1C_3=R_2C_4=50\mu s, 75\mu s$. Table 3 shows the values of R_1, R_2, C_3, C_4 and the de-emphasis constants.

Table 3

R1 (R2)	C2 (C4)50 μs	C2 (C4)75 μs
33k Ω	1500pF	2200pF
39k Ω	1200pF	2000pF
51k Ω	1000pF	1500pF
62k Ω	750pF	1000pF
82k Ω	620pF	910pF
110k Ω	470pF	680pF
130k Ω	390pF	560pF

The post amplifier requires feedback capacitors C_3, C_4 regardless of the de-emphasis characteristic. Without these capacitors, the stereo distortion gets worse.

4. Low-pass filter

Fig. 8 shows a sample circuit configuration where an LC filter is used as the low-pass filter and Fig. 16 shows a sample characteristic of this filter. As compared with the LPF (BL-13) in the Sample Application Circuit, the use of this filter makes the attenuation less at 19kHz, 38kHz ; therefore, carrier leak at the LPF output causes the stereo distortion and separation characteristic to get worse than specified in the Operating Characteristics. For the stereo distortion, the BL-13 provides approximately 0.02%, while the LC filter provides approximately 0.5%

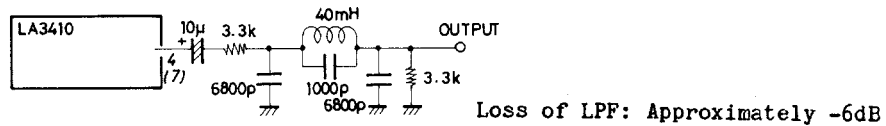
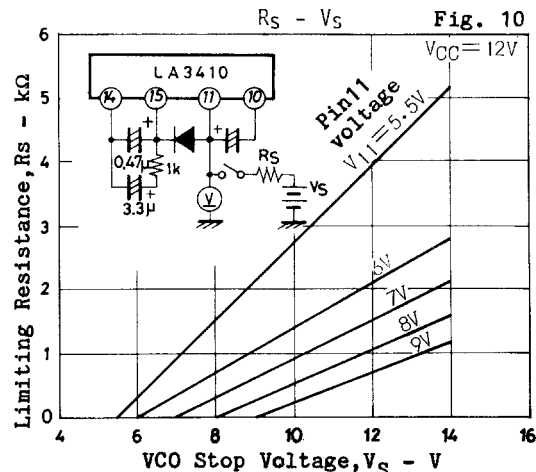
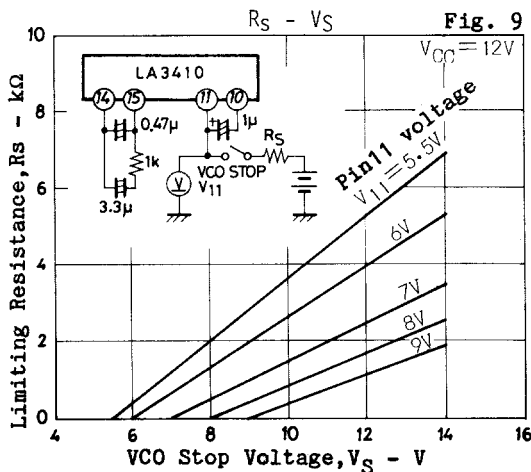
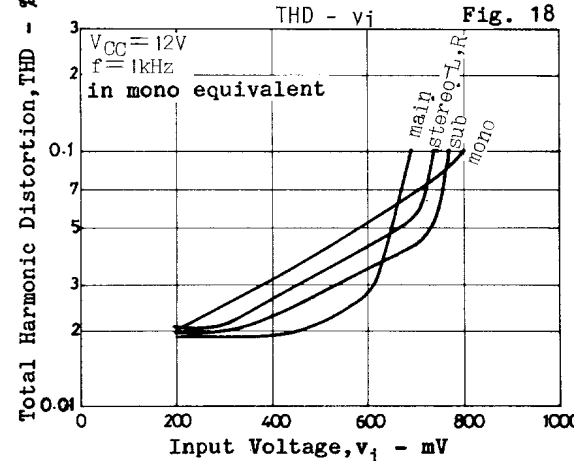
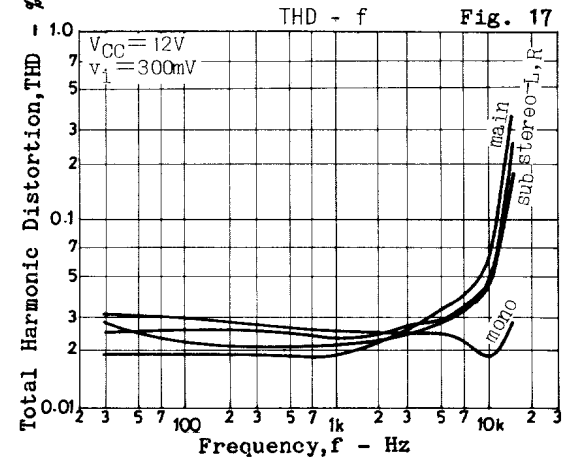
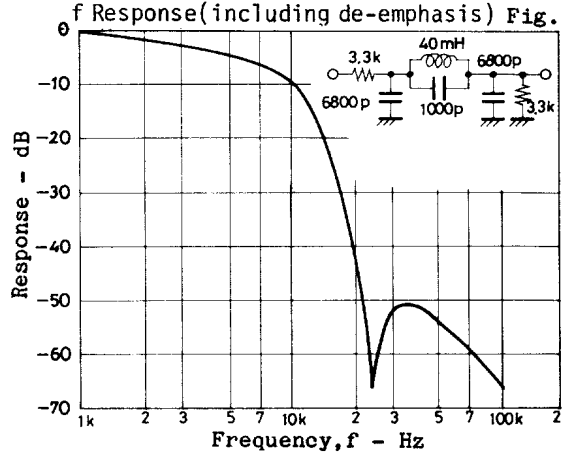
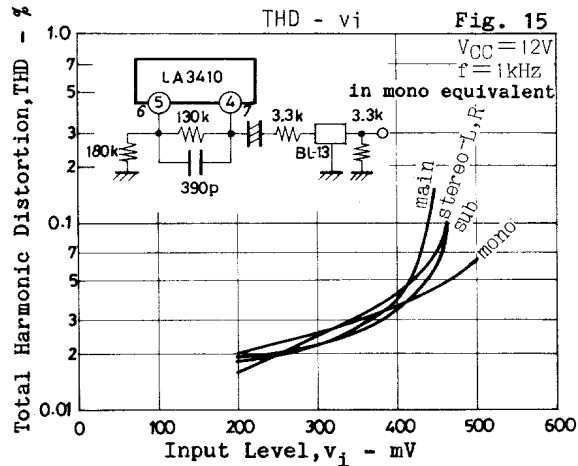
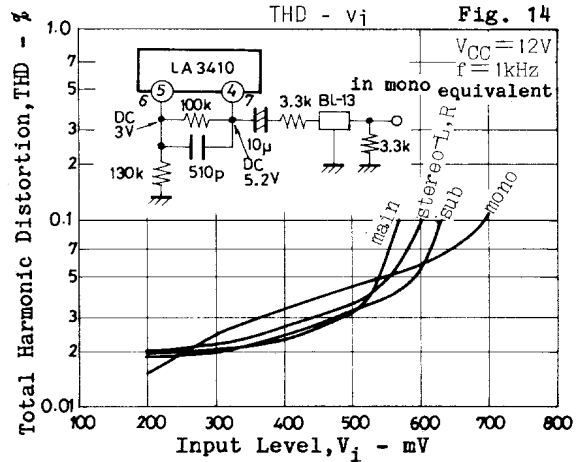
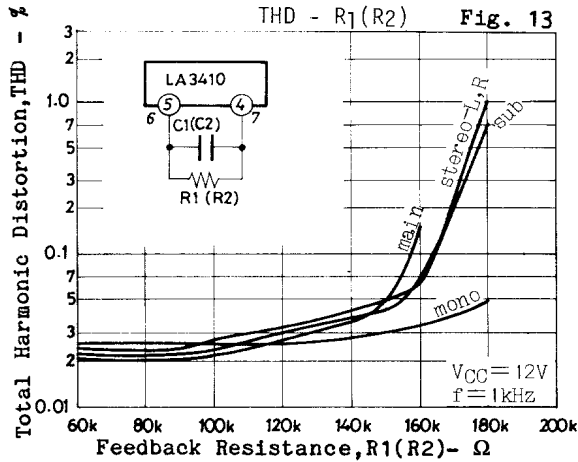
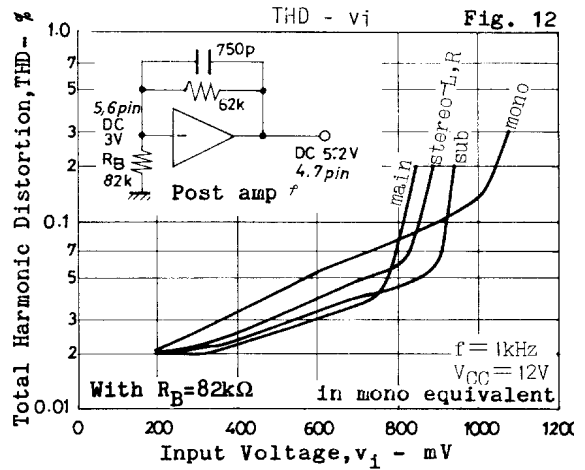
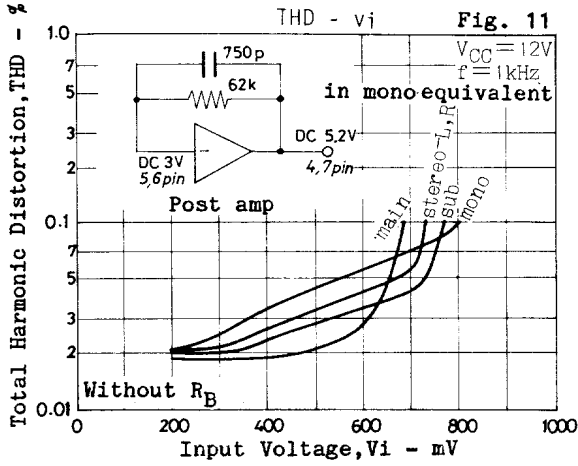

Fig. 8

Unit (resistance : Ω , capacitance : F)



LA3410



Unit (resistance : Ω , capacitance : F)

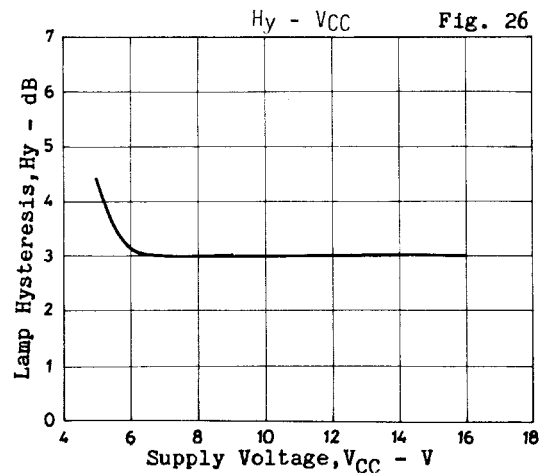
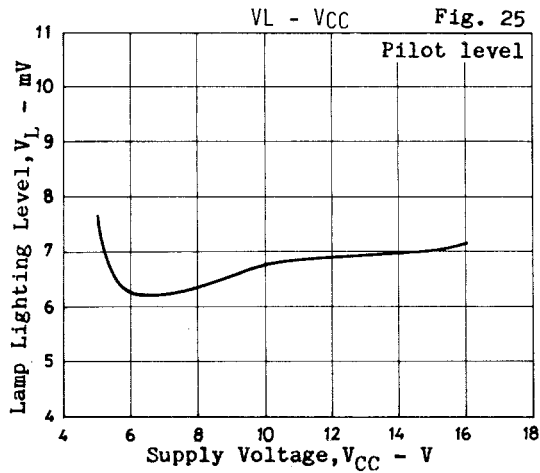
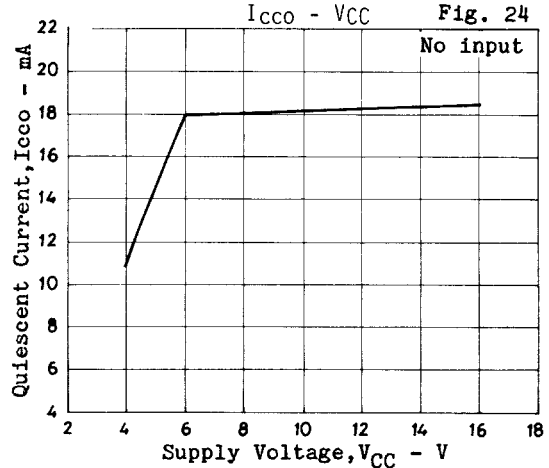
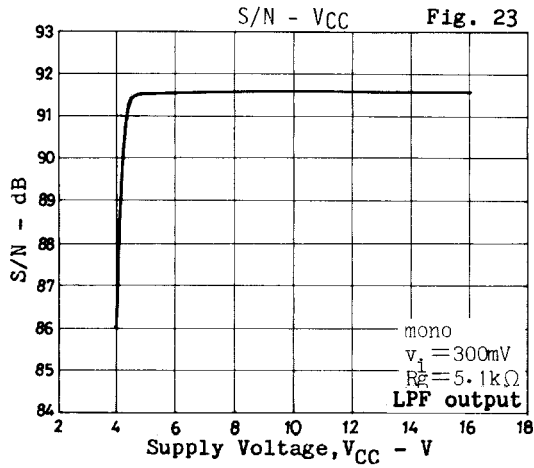
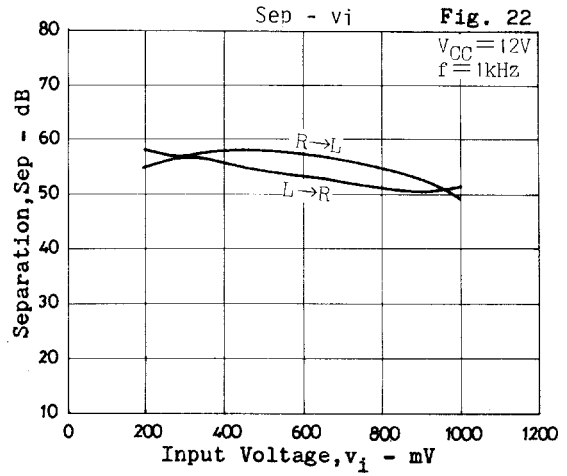
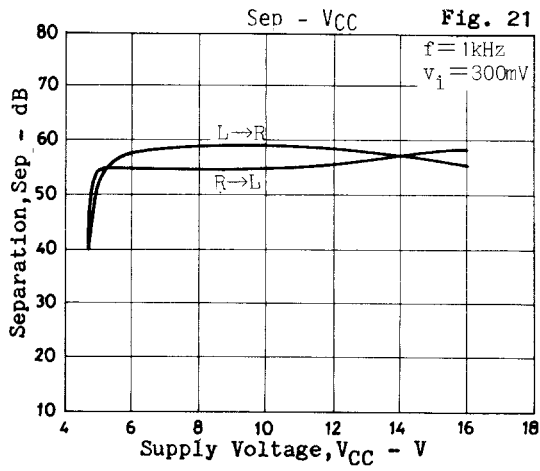
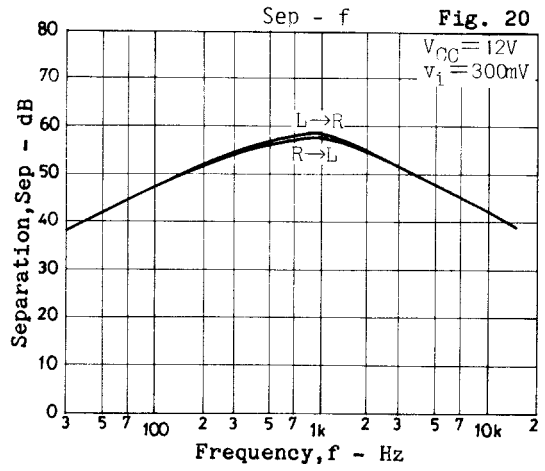
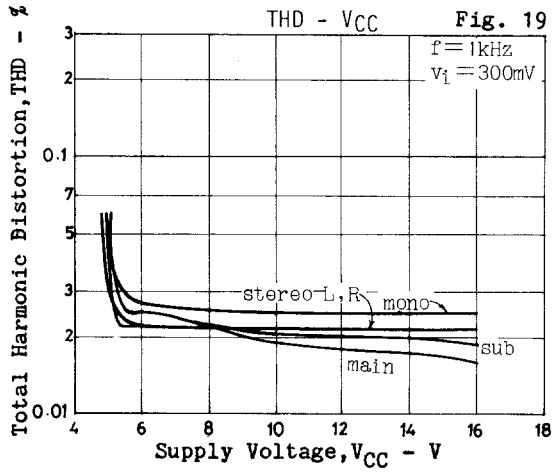

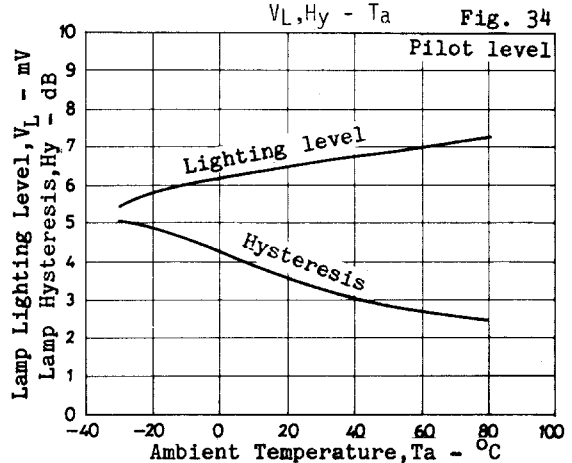
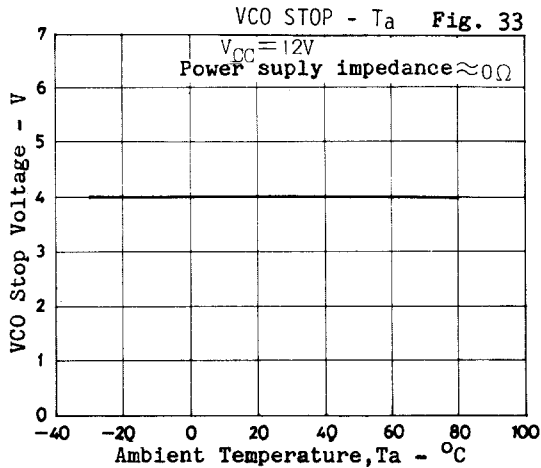
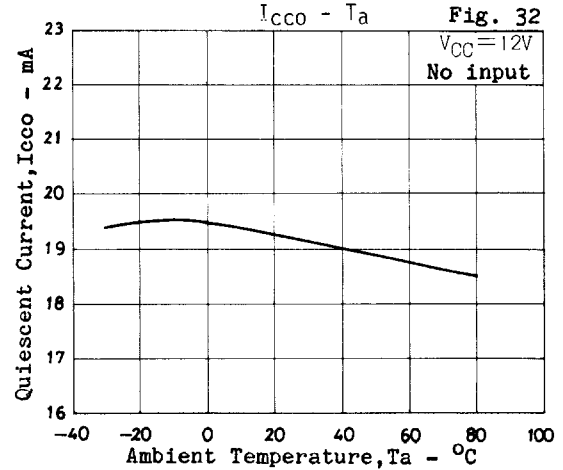
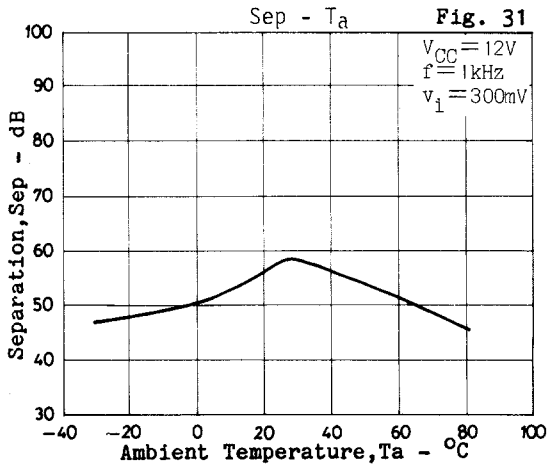
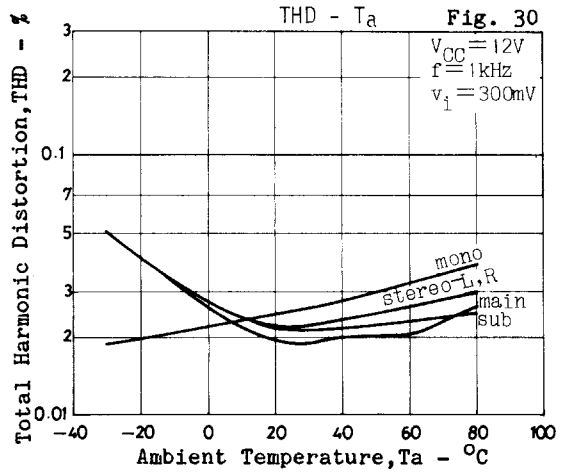
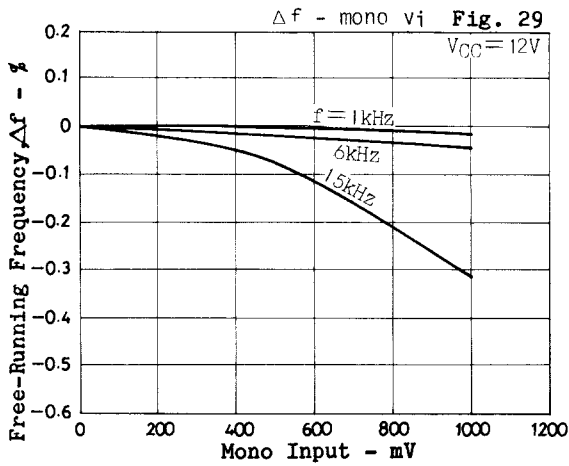
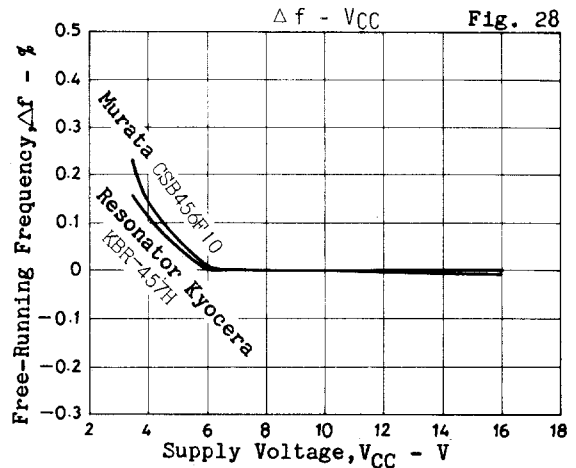
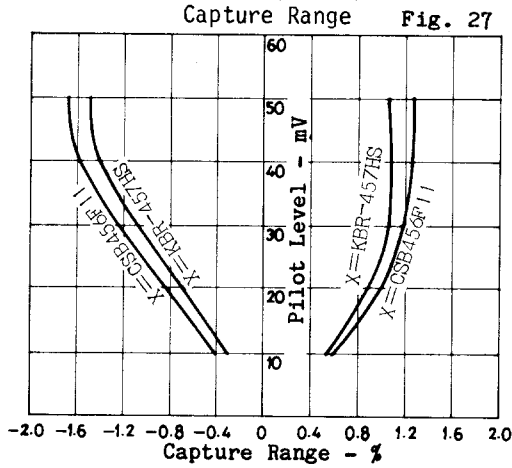

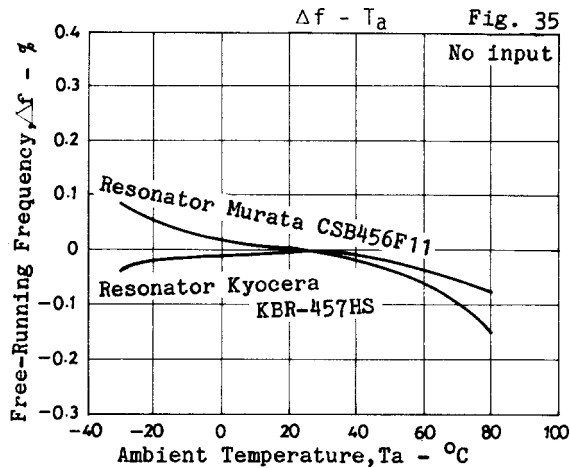

- Specifications of any and all SANYO products described or contained herein stipulate the performance, characteristics, and functions of the described products in the independent state, and are not guarantees of the performance, characteristics, and functions of the described products as mounted in the customer's products or equipment. To verify symptoms and states that cannot be evaluated in an independent device, the customer should always evaluate and test devices mounted in the customer's products or equipment.
- SANYO Electric Co., Ltd. strives to supply high-quality high-reliability products. However, any and all semiconductor products fail with some probability. It is possible that these probabilistic failures could give rise to accidents or events that could endanger human lives, that could give rise to smoke or fire, or that could cause damage to other property. When designing equipment, adopt safety measures so that these kinds of accidents or events cannot occur. Such measures include but are not limited to protective circuits and error prevention circuits for safe design, redundant design, and structural design.
- In the event that any or all SANYO products (including technical data, services) described or contained herein are controlled under any of applicable local export control laws and regulations, such products must not be exported without obtaining the export license from the authorities concerned in accordance with the above law.
- No part of this publication may be reproduced or transmitted in any form or by any means, electronic or mechanical, including photocopying and recording, or any information storage or retrieval system, or otherwise, without the prior written permission of SANYO Electric Co., Ltd.
- Any and all information described or contained herein are subject to change without notice due to product/technology improvement, etc. When designing equipment, refer to the "Delivery Specification" for the SANYO product that you intend to use.
- Information (including circuit diagrams and circuit parameters) herein is for example only; it is not guaranteed for volume production. SANYO believes information herein is accurate and reliable, but no guarantees are made or implied regarding its use or any infringements of intellectual property rights or other rights of third parties.

This catalog provides information as of February, 2000. Specifications and information herein are subject to change without notice.