



LA4485

5 W, Two-channel Power Amplifier with Very Few External Parts

Overview

The LA4485 is a 5 W, two-channel power amplifier IC that requires a minimum of external parts, making it ideal for radio cassette players and car stereo equipment.

The LA4485 eliminates the need for bootstrap capacitors, negative feedback capacitors, and oscillation prevention CR parts, all of which were necessities for power ICs previously. All of these functions are now on chip, keeping the number of external parts to an absolute minimum. The LA4485 is part of the Power (Stylish Power) Series, and supports two modes: dual and BTL.

Features

- 5 W \times 2 output power in dual mode, and 15 W in BTL mode
- Minimum external parts for the Power Series count: 4 or 5 parts in dual mode; 3 or 4 parts in BTL mode
- Protection circuits
 - Overvoltage protection
 - Thermal protection
 - DC output short-circuit protection (to V_{CC} and to GND)
- Circuitry designed to handle $+V_{CC}$ applied to the outputs
- Pop noise reduction
- Standby switch
- Muting function

Package Dimensions

unit : mm

3107-SIP13H

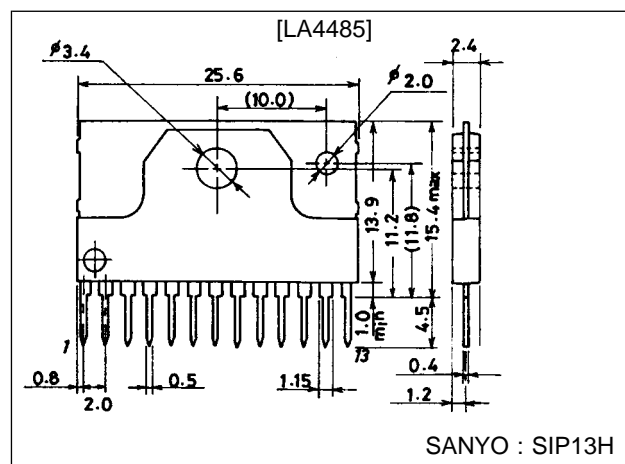

Specifications

Maximum Ratings at $T_a = 25^\circ\text{C}$

Parameter	Symbol	Conditions	Ratings	Unit
Maximum supply voltage	V_{CC} max	No signal	24	V
Surge supply voltage	V_{CC} surge *	Based on the JASO standard	50	V
Peak output current	I_O peak	Per channel	3.3	A
Allowable power dissipation	P_d max	With infinite heat sink	15	W
Operating temperature	T_{opr}		-30 to +80	$^\circ\text{C}$
Storage temperature	T_{stg}		-40 to +150	$^\circ\text{C}$

*: By the π type B check point method.

Operating Conditions at $T_a = 25^\circ\text{C}$

Parameter	Symbol	Conditions	Ratings	Unit
Recommended supply voltage	V_{CC}		13.2	V
Supply voltage range	V_{CC} op	Must not be over package P_d	7.5 to 18	V
Recommended load resistance range	R_L	Dual	2 to 8	Ω
		BTL	4 to 8	Ω

SANYO Electric Co., Ltd. Semiconductor Business Headquarters

TOKYO OFFICE Tokyo Bldg., 1-10, 1 Chome, Ueno, Taito-ku, TOKYO, 110 JAPAN

73096HA(II)/D2893TS/9041TS No.3680-1/20

LA4485

Operating Characteristics at $T_a = 25^\circ\text{C}$, $V_{CC} = 13.2\text{ V}$, $R_L = 4\ \Omega$, $R_g = 600\ \Omega$, $f = 1\text{ kHz}$, Dual

Parameter	Symbol	Conditions	min	typ	max	Unit
Standby current	I_{st}	Pin 9 to GND, Standby switch OFF			10	μA
Quiescent supply current	I_{CCO}	$R_g = 0$	40	80	160	mA
Voltage gain	VG1	Dual: $V_O = 0\text{ dBm}$	43	45	47	dB
	VG2	BTL: $V_O = 0\text{ dBm}$		51		dB
Output power	P_{O1}^*	Dual: THD = 10%	4	5		W
	P_{O2}	BTL: THD = 10%	11	15		W
Total harmonic distortion	THD	$P_O = 1\text{ W}$		0.15	0.8	%
Channel separation	CH sep	$V_O = 0\text{ dBm}$, $R_g = 0$	45	55		dB
Output noise voltage	V_{NO}	$R_g = 0$, 20 Hz to 20 kHz bandpass filter		0.15	0.5	mV
Ripple rejection ratio	SVRR	$f_R = 100\text{ Hz}$, $V_R = 0\text{ dBm}$, decoupling capacitor connected	40	50		dB

*: $P_{O1} = 6\text{ W}$ (typ) when $V_{CC} = 14.4\text{ V}$
 $V_{off} \pm 250\text{ mV}$ for BTL-mode

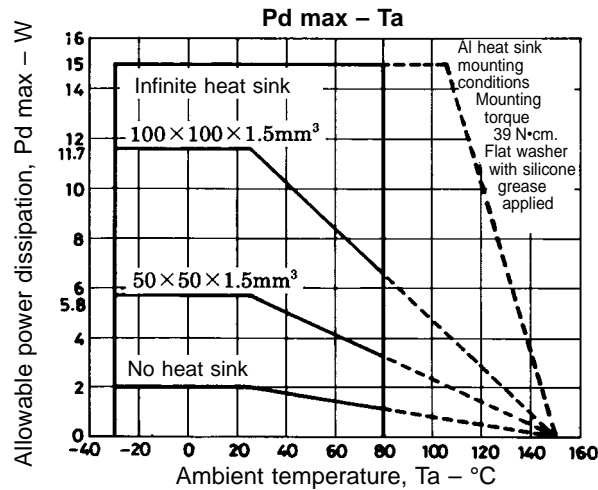

Equivalent Circuit Block Diagram

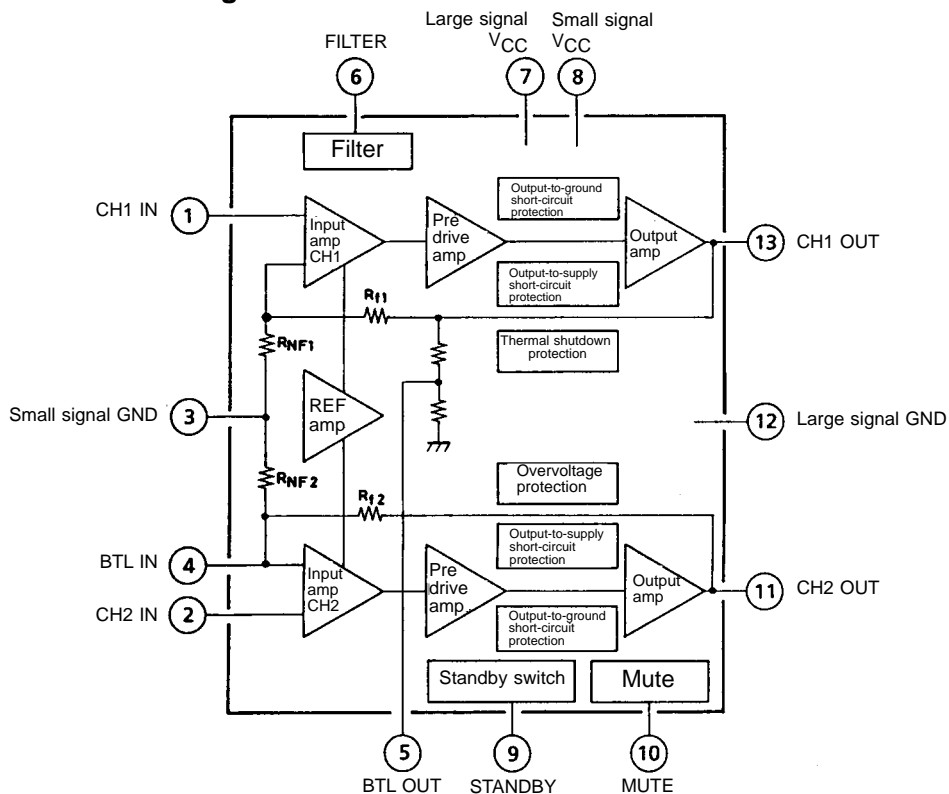

Recommended LA4485 External Parts Arrangement (Dual-mode)

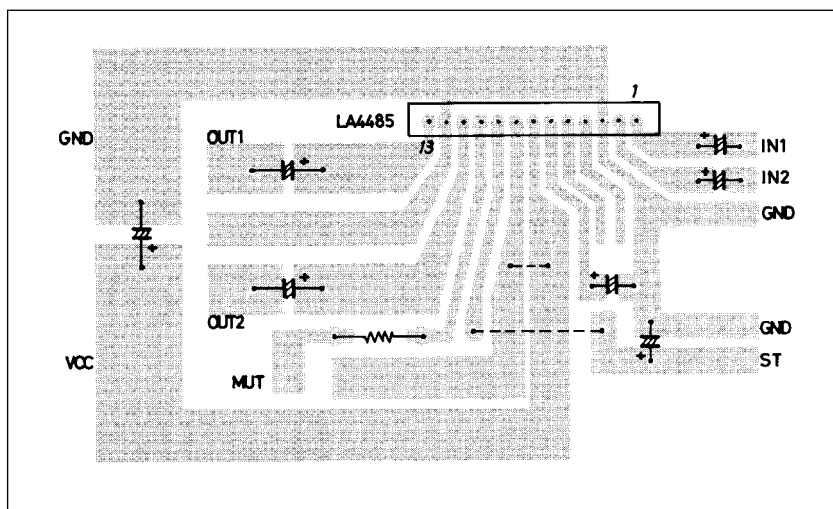

95.0 × 67.0 mm²

IC Usage Notes

Maximum ratings

Care must be taken when operating the LA4485 close to the maximum ratings as small changes in the operating conditions can cause the maximum ratings to be exceeded, thereby breakdown will be caused.

Printed circuit board connections

Care must be taken when designing the circuit of printed board so as not to form feedback loops, particularly with the small-signal and large-signal ground connections.

Notes on LA4485 heatsink mounting

1. Mounting torque must be in the range 39 to 59 N•cm.
2. The spacing of the tapped holes in the heatsink must match the spacing of the holes in the IC tab.
3. Use screws with heads equivalent to truss head machine screws and binding head machine screws stipulated by JIS for the mounting screws. Furthermore, washers must be used to protect the surface of the IC tab.
4. Make sure that there is no foreign matter, such as cutting debris, between the IC tab and the heatsink. If a heat conducting compound is applied between the contact surfaces, make sure that it is spread uniformly over the entire surface.
5. Because the heatsink mounting tab and the heatsink are at the same electric potential as the chip's GND (large signal GND), care must be taken when mounting the heatsink on more than one device.
6. The heatsink must be mounted before soldering the pins to the PCB.

Comparison of External Parts Required

External parts	Existing device	LA4485
Output coupling capacitors	Yes	Yes
Input coupling capacitors	Yes	Yes
Bootstrap capacitors	Yes	No
Feedback capacitors	Yes	No
Filter capacitor	Yes	Optional
Phase compensating capacitor	Yes	No
Oscillation-quenching mylar capacitors	Yes	No
Oscillation-quenching resistors	Yes	No
Others	No	Optional
Total (for dual-mode)	15 to 16 parts	4 to 6 parts

Note: Supply capacitors, contained within the power IC, are not counted in both existing and new devices.

LA4485

Operating Pin Voltages at $V_{CC} = 13.2\text{ V}$

Pin No.	Name	Function	Pin voltage (Reference value)
1	CH1 IN	Channel 1 input.	1.4 V ($2 V_{BE}$)
2	CH2 IN	Channel 2 input.	1.4 V ($2 V_{BE}$)
3	SS GND	Small-signal ground	0 V
4	BTL IN	BTL-mode feedback input.	45 mV
5	BTL OUT	BTL-mode feedback output.	3.1 V ($\approx 1/4 V_{CC}$)
6	FILTER	Filter capacitor connection.	6.6 V ($\approx 1/2 V_{CC}$)
7	LS V_{CC}	Large-signal supply	13.2 V (V_{CC})
8	SS V_{CC}	Small-signal supply	13.2 V (V_{CC})
9	STANDBY	Standby control input.	5 V
10	MUTE	Mute control input.	0 V
11	CH2 OUT	Channel 2 output.	6.3 V
12	LS GND	Large-signal ground	0 V
13	CH1 OUT	Channel 1 output.	6.3 V

Note: Each pin is so arranged lest the IC should be broken even if inserted reversely.

LA4485 Sample Application Circuit

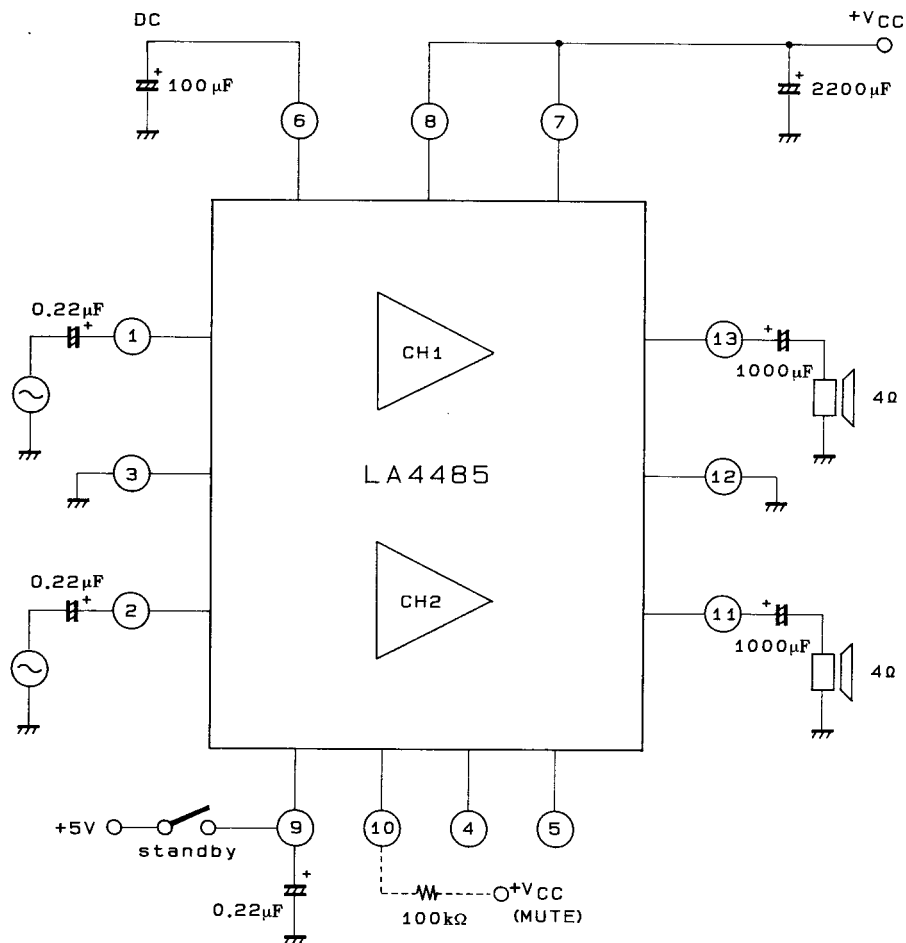

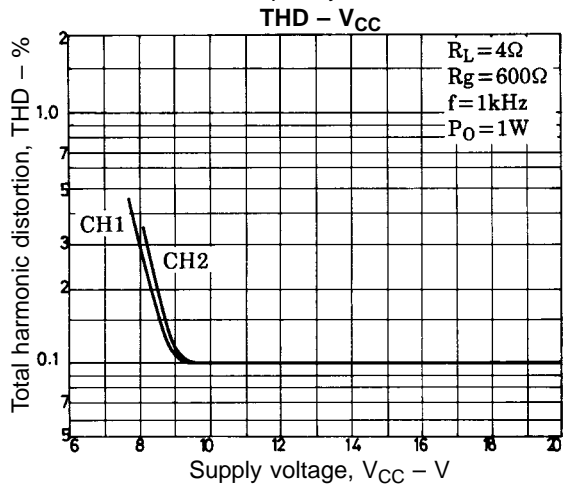
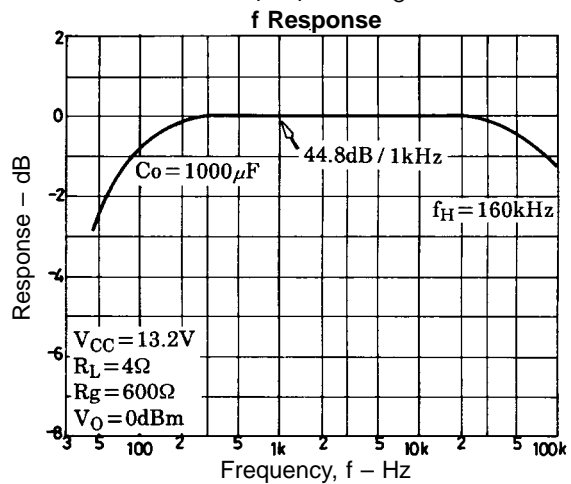
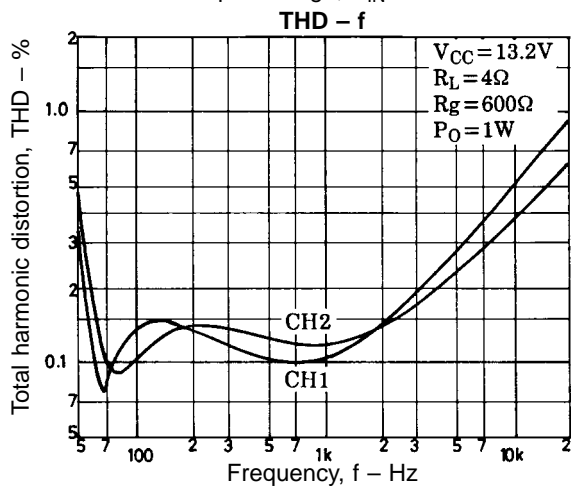
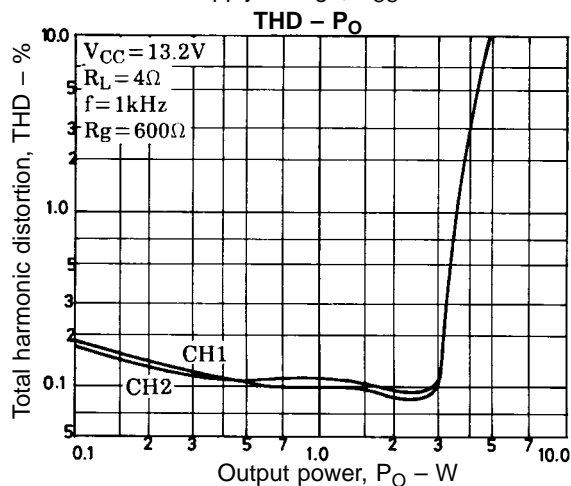
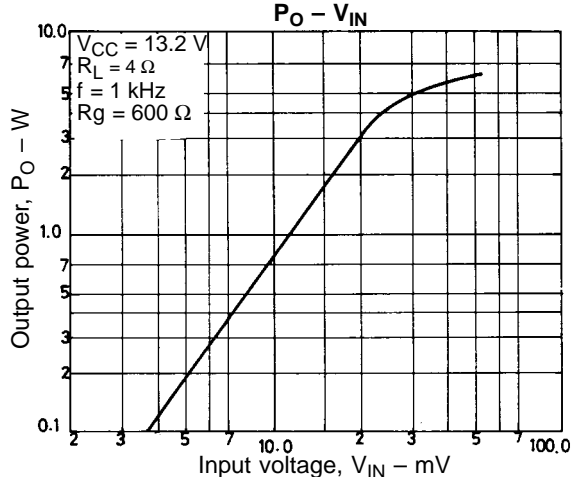
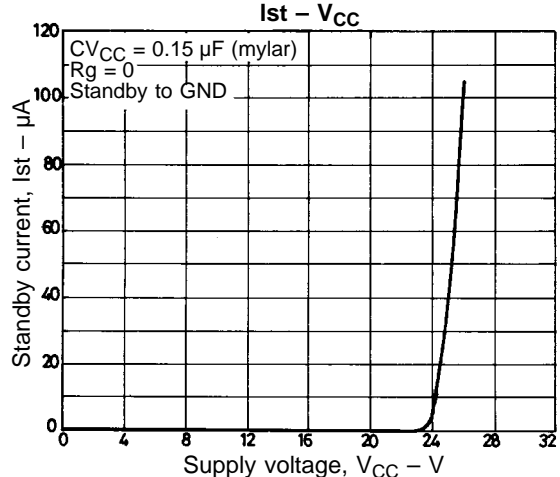
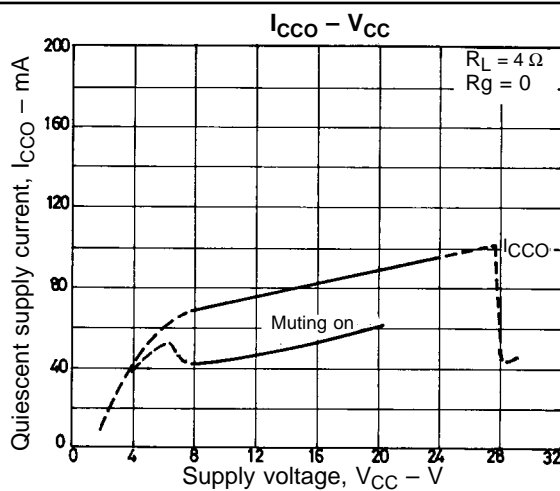
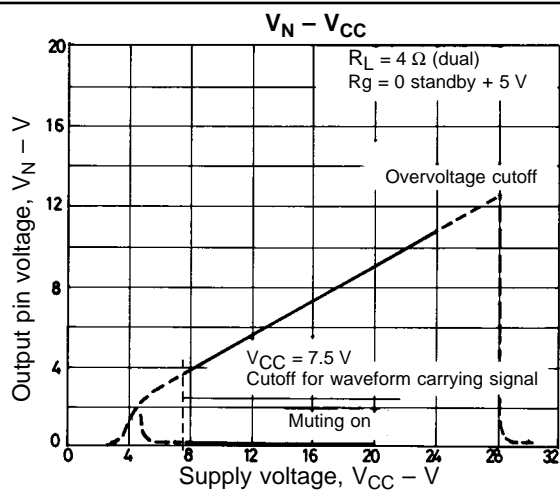

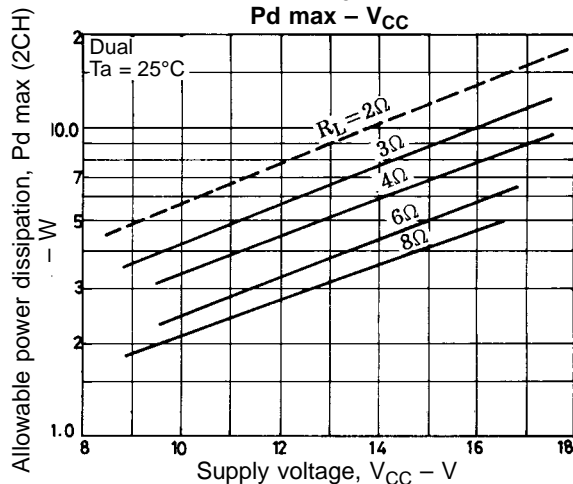
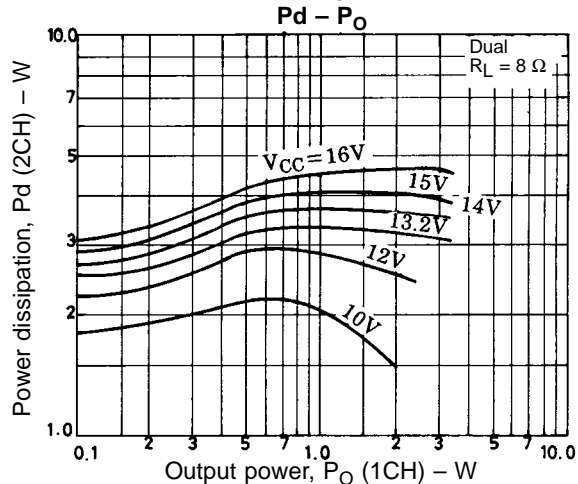
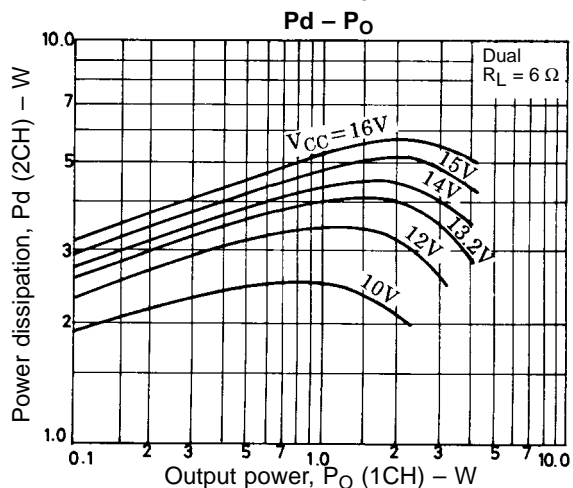
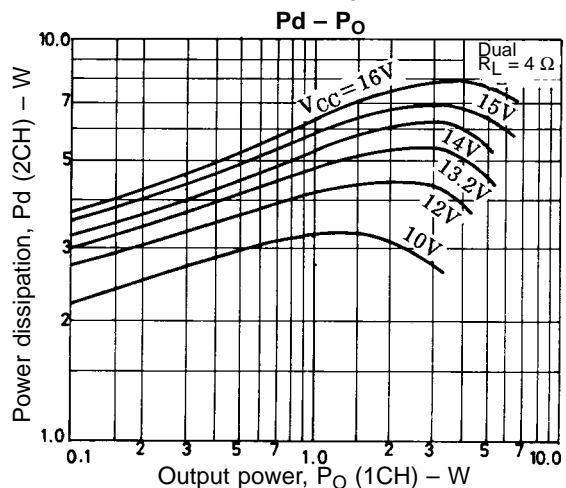
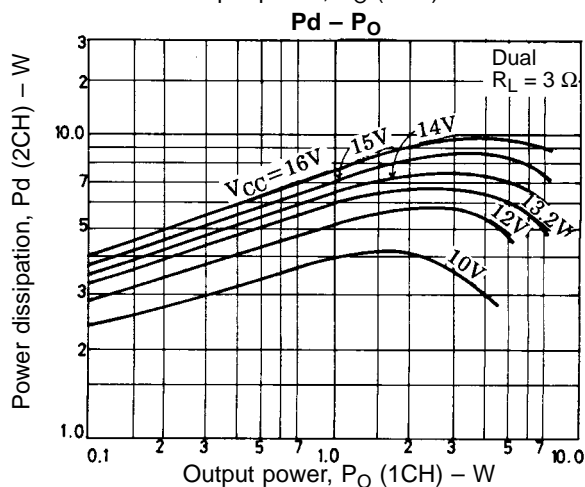
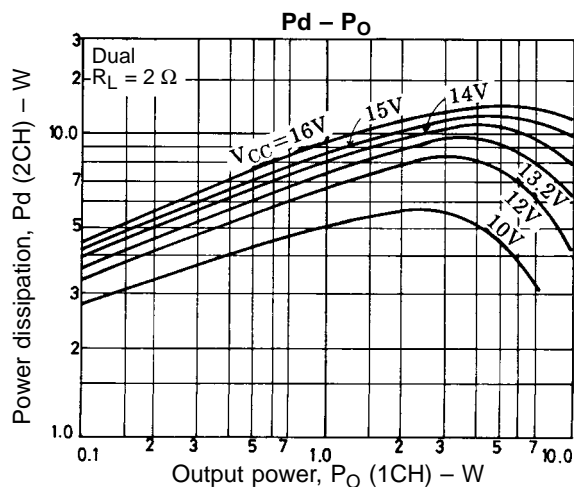
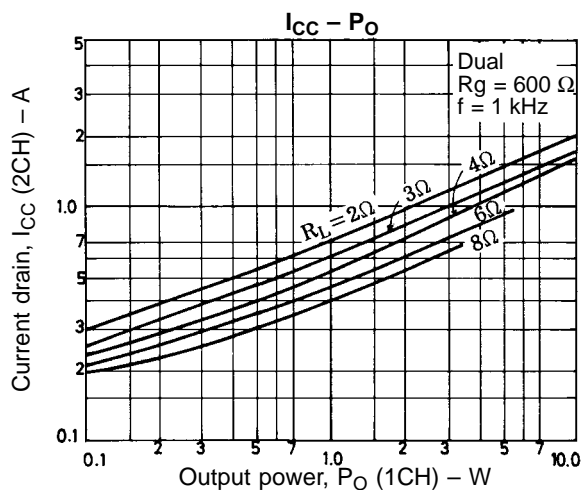
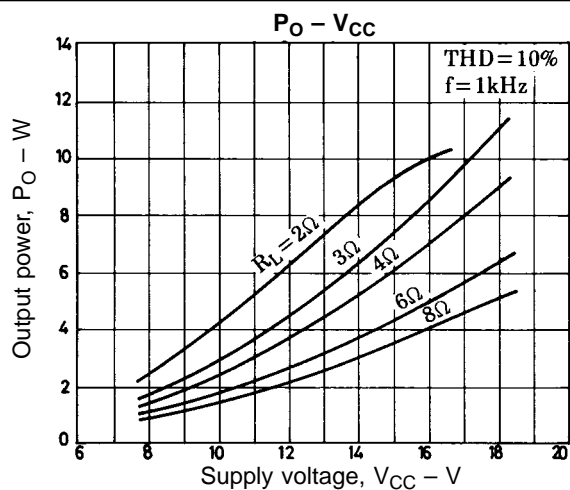

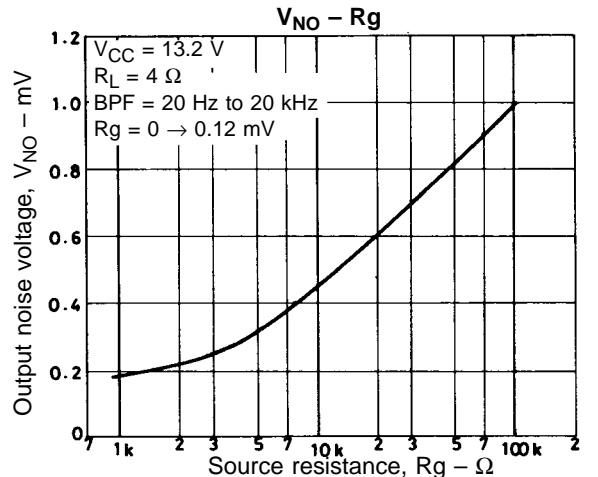
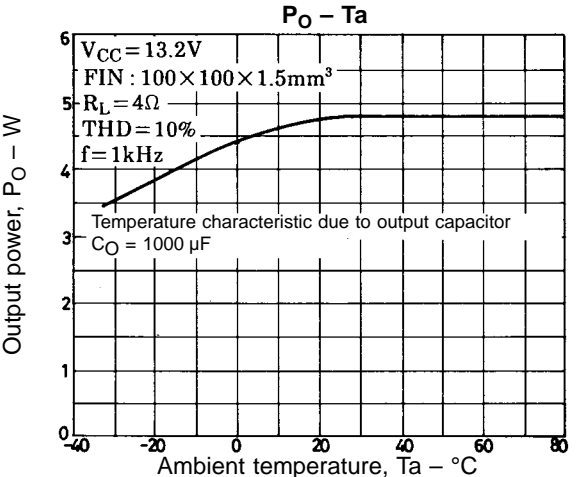
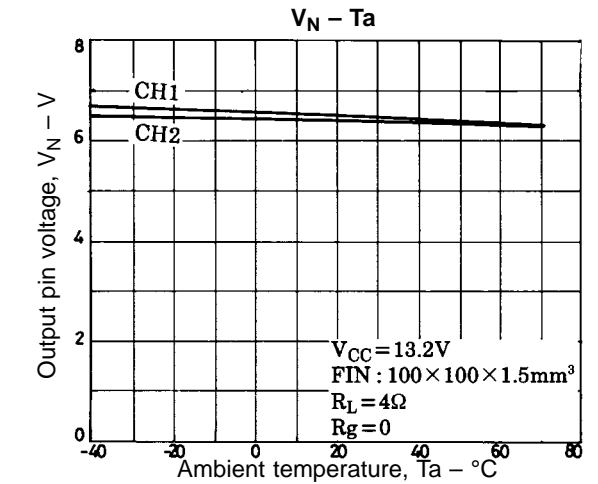
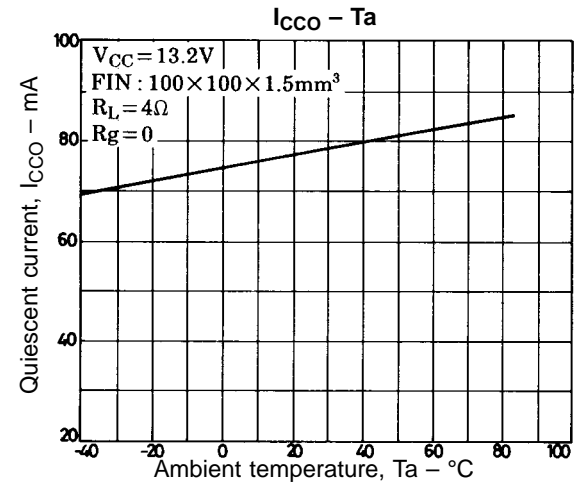
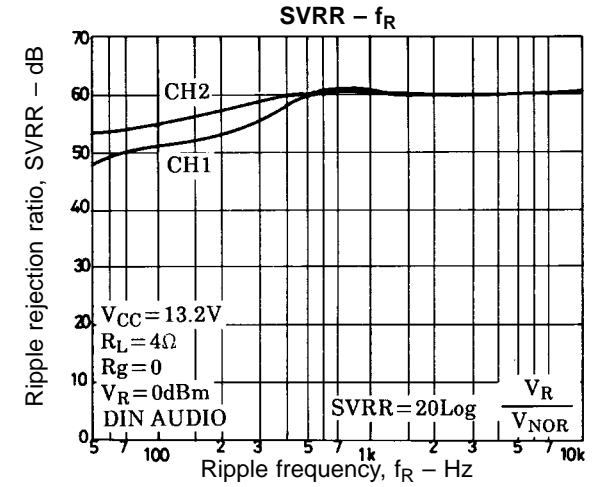
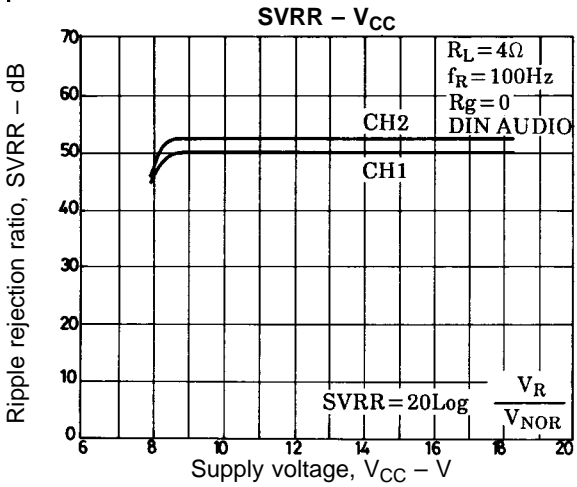
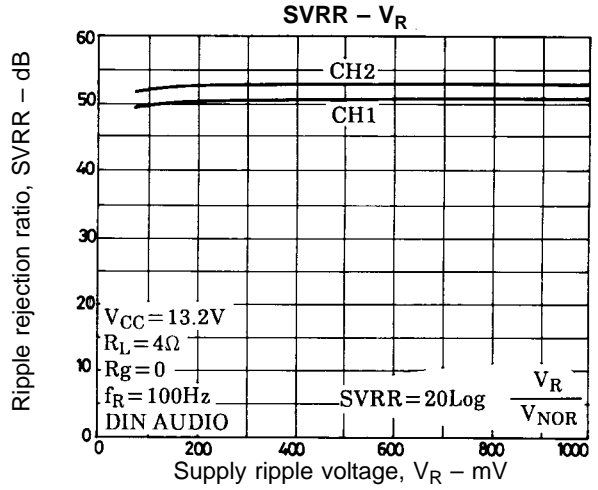
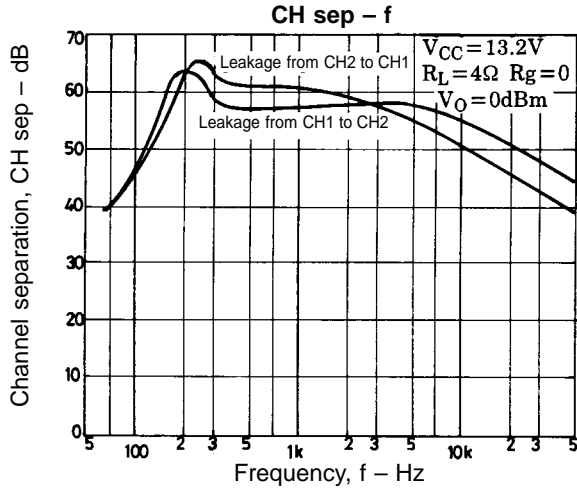

LA4485

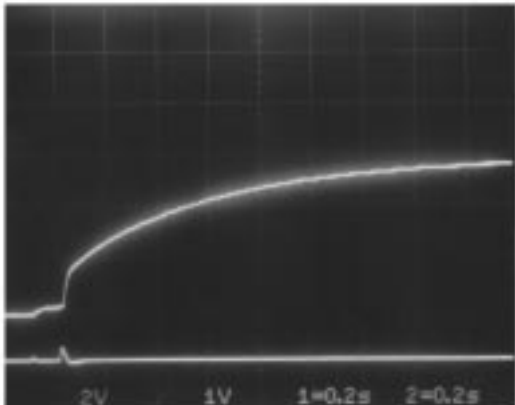

Output
DC trace

Speaker
terminal

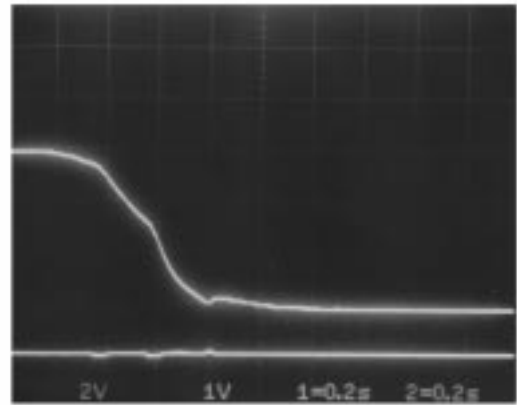

$V_{CC} = 13.2 \text{ V}$, standby supply +5 V,
 $R_L = 4 \Omega$, $R_g = 0$
 Main switch ON/OFF test

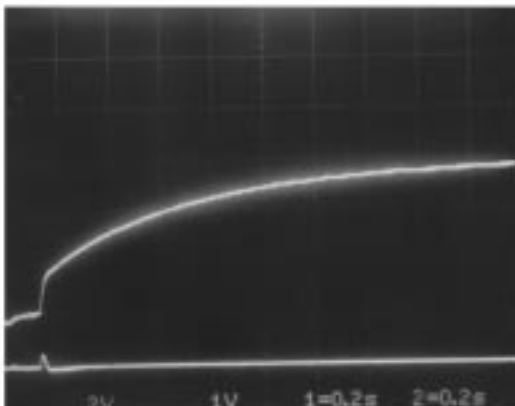

Output
DC trace

Speaker
terminal

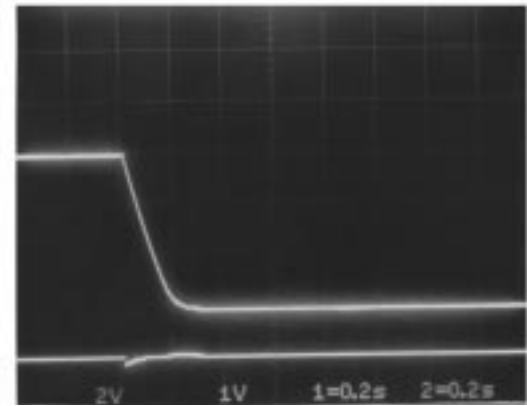

$V_{CC} = 13.2 \text{ V}$, standby supply +5 V,
 $R_L = 4 \Omega$, $R_g = 0$
 Standby switch ON/OFF test

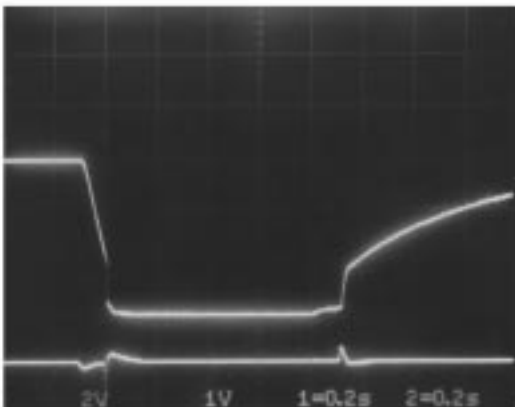

$V_{CC} = 13.2 \text{ V}$,
 $R_L = 4 \Omega$,
 $R_g = 0$,
 Mute ON/OFF

↳ Switching noise decreases as $C_{IN} = 0.22 \mu\text{F}$ (Input) is increased. (ex. $2.2 \mu\text{F}$)

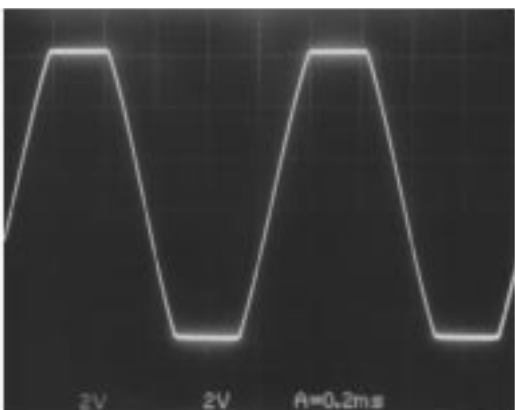

$V_{CC} = 13.2 \text{ V}$,
 $R_L = 4 \Omega$,
 $R_g = 600 \Omega$,
 THD = 10%,
 $f = 1 \text{ kHz}$,
 Output DC waveform

Dual-mode Operation Notes

- Use the input capacitor C_{IN} in the range of 0.22 μF to 1.0 μF .

Parameter	$C_{IN} = 0.22 \mu\text{F}$	$C_{IN} = 1.0 \mu\text{F}$
Start-up time (ts)	0.15 s	0.25 s
Attack noise when using the muting function	Somewhat noticeable	Good

Speaker turn-ON transient noise increased significantly when C_{IN} is 2.2 μF or greater.

- The DC (filter) capacitor should be 100 μF or greater.

Parameter	100 μF or less	100 μF or more
Standby-off output capacitor discharge circuit	*1. Does not operate. Repeated on/off: poor	*2. Operates normally. On/off: good
Ripple rejection ratio (SVRR)	Somewhat worse 40 dB	Good 50 dB
V_N rise rate when main or standby is turned "on"	Fast	Slow

Note:

*1. Slow as a result of natural discharge.

*2. Approximately 0.3 seconds as a result of forced discharge.

- Use the standby supply capacitor in the range of 0.22 μF to 0.47 μF .

The V_N trace for standby OFF changes and speaker turn-ON transient noise is increased significantly when the capacitor is 1 μF or greater. If the standby function is not used, this capacitor must be removed and pin 9 must be pulled up to the power supply.

- The output capacitor's recommended value for C_O is 1,000 μF .

Smaller capacitance will worsen the roll-off frequency f_L and P_O in a low range.

- The recommended power supply capacitor is approximately 2,200 μF , but other capacitors than 2,200 μF can be used according to the application's design.

Using a capacitor with this value, the load on the supply can be as high as 56 Ω while still providing good supply stability during momentary supply glitches. Note that using a 0.15 μF capacitor can cause oscillations if the supply impedance increases. (Example: Mild oscillation results if the power supply capacitor is open.)

- STANDBY pin 9 IC internal circuit

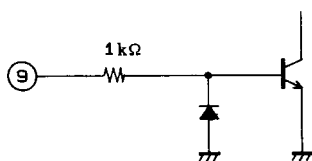

- MUTE pin 10 IC internal circuit

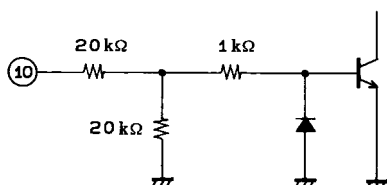

LA4485

- Input pin 1/2 IC internal circuit

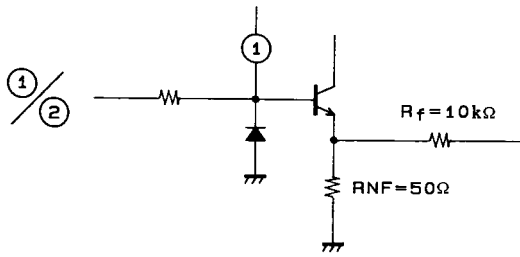

- Output pin 11/13 IC internal circuit

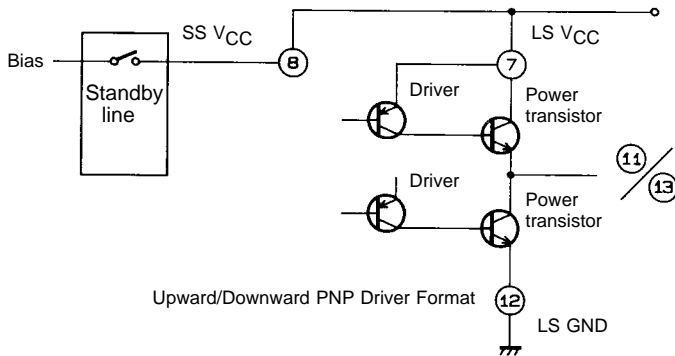

- The minimum configuration for dual-mode operation

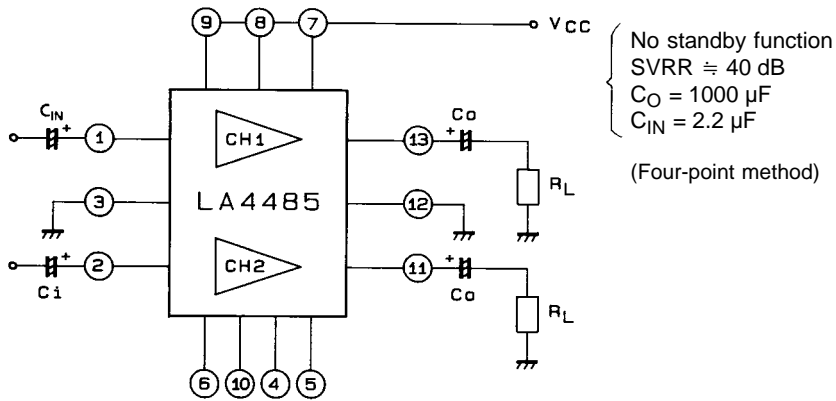

- Insert capacitors of 1000 pF between each input and ground to prevent external noise.
- When the load (R_L) or the supply voltage (V_{CC}) is increased, turning the standby switch or the main switch on under strong input conditions will activate the IC's internal pseudo ASO protection circuit for the upper power transistor ($V_{CE} \times I_{CP}$). This causes output oscillations or intermittent operation (The reference area is shown in Figure 1 below). However, strong input tests after the bias has stabilized have no problems. They also protect the upper power transistors close to the limits of ASO when all signal switches are on. Therefore, when using this IC under these conditions, the circuit design should obey the following condition:
 Signal generation time > Start-up time of the power amplifier IC
 or some other method of attaining the zero-volume condition should be adopted.
- An undervoltage protection circuit operates when the voltage is 7.5 V or lower.

This figure shows the pseudo ASO protection area when strong signal is input, and switch is ON: the upper power transistors have an area where $V_{CE} \times I_{CP}$ load is caused.

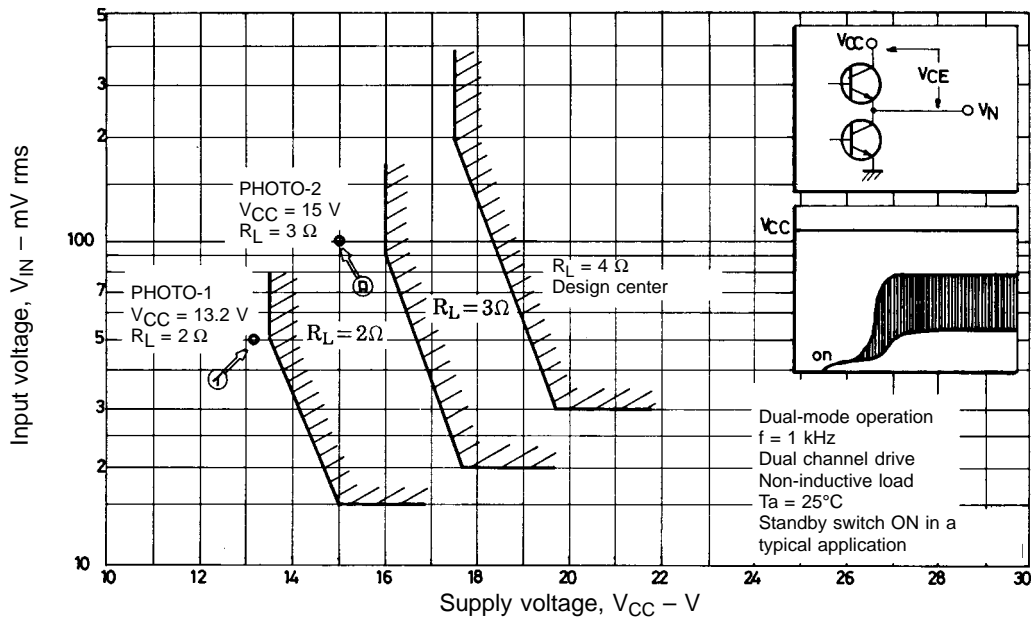

Strong signal input after switch-ON is OK.
 In BTL-mode operation, the load is $R_L \times 2$

Figure 1

- i) The operating conditions for the PHOTO-1 series in dual mode are $V_{CC} = 13.2\text{ V}$, $R_L = 2\ \Omega$, $f = 1\text{ kHz}$, $V_{IN} = 50\text{ mV}$ and standby switch ON.

“X-Y path observed within the normal area”: checking each channel

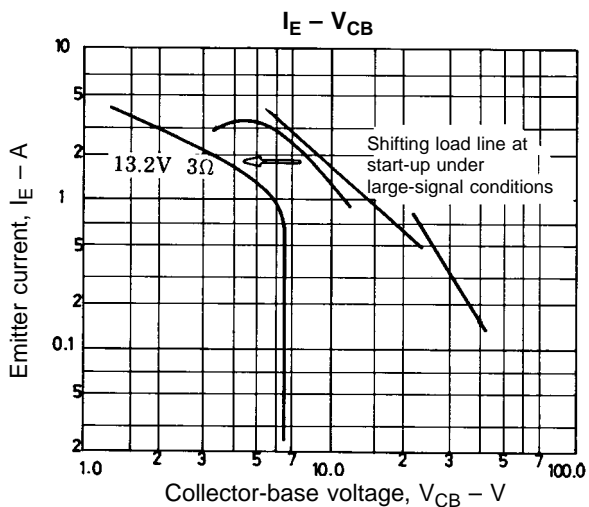
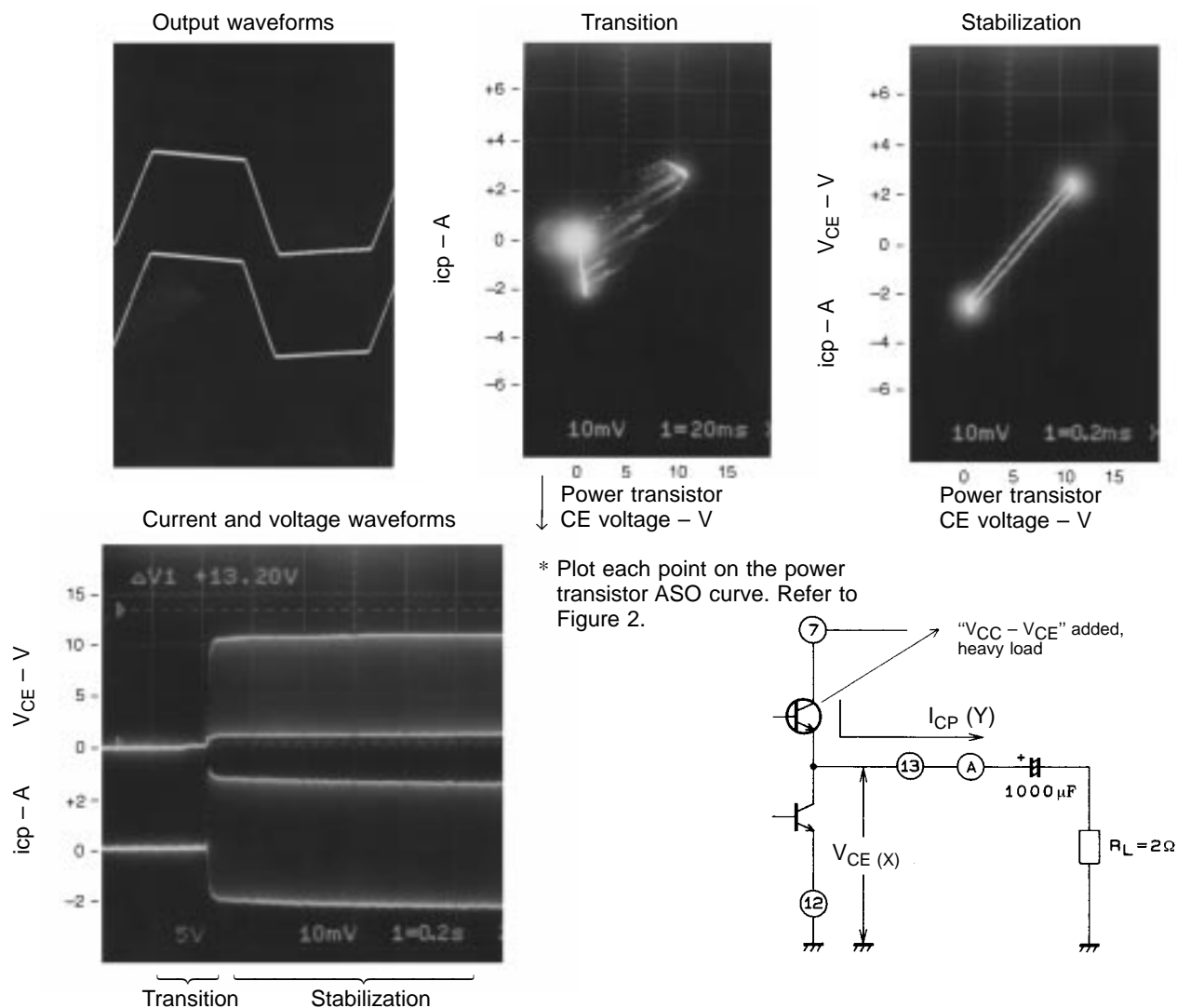
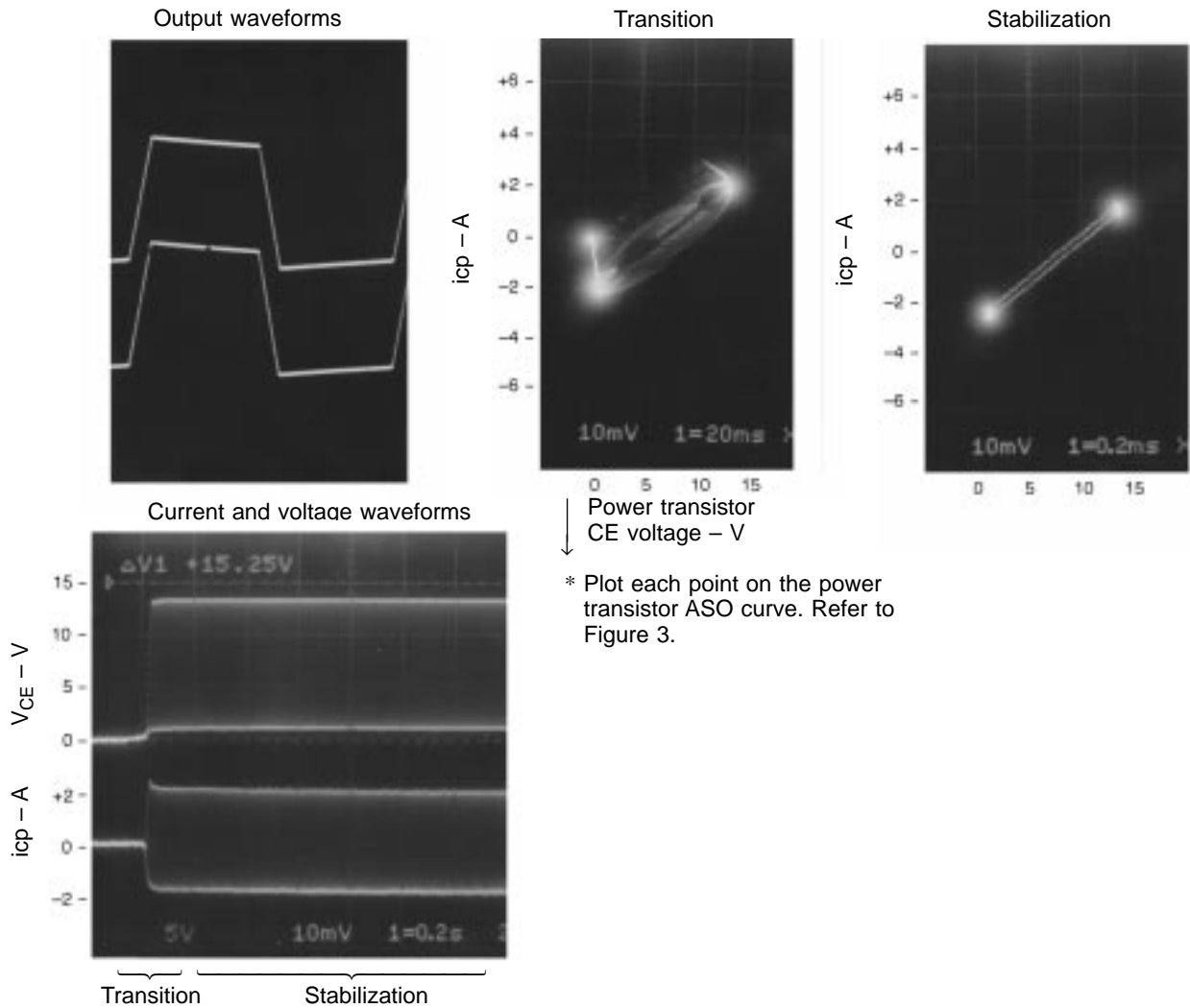

Figure 2

Upper power transistor
The load line becomes more closely aligned with the vertical axis because of the load.

- ii) The operating conditions for the PHOTO-2 in dual mode are $V_{CC} = 15\text{ V}$, $R_L = 3\ \Omega$, $f = 1\text{ kHz}$, $V_{IN} = 100\text{ mV}$ and standby switch ON.

“X-Y path observed within the normal area”



Power transistor
CE voltage - V

* Plot each point on the power transistor ASO curve. Refer to Figure 3.

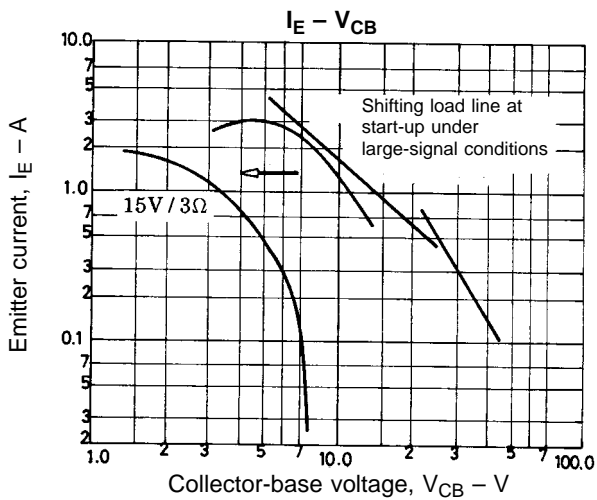
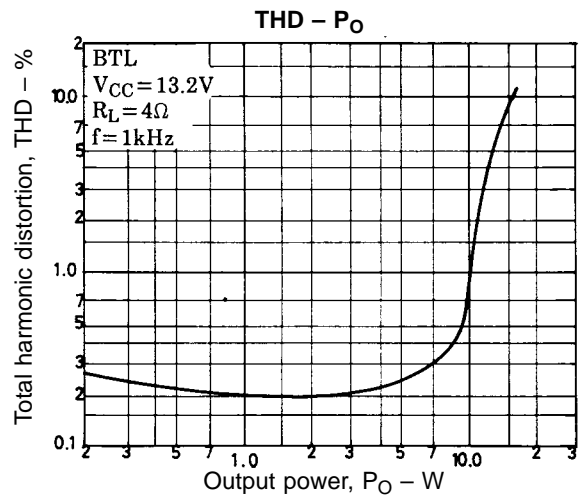
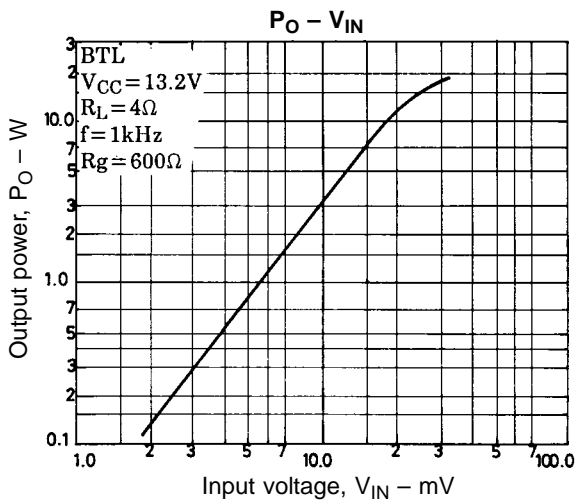
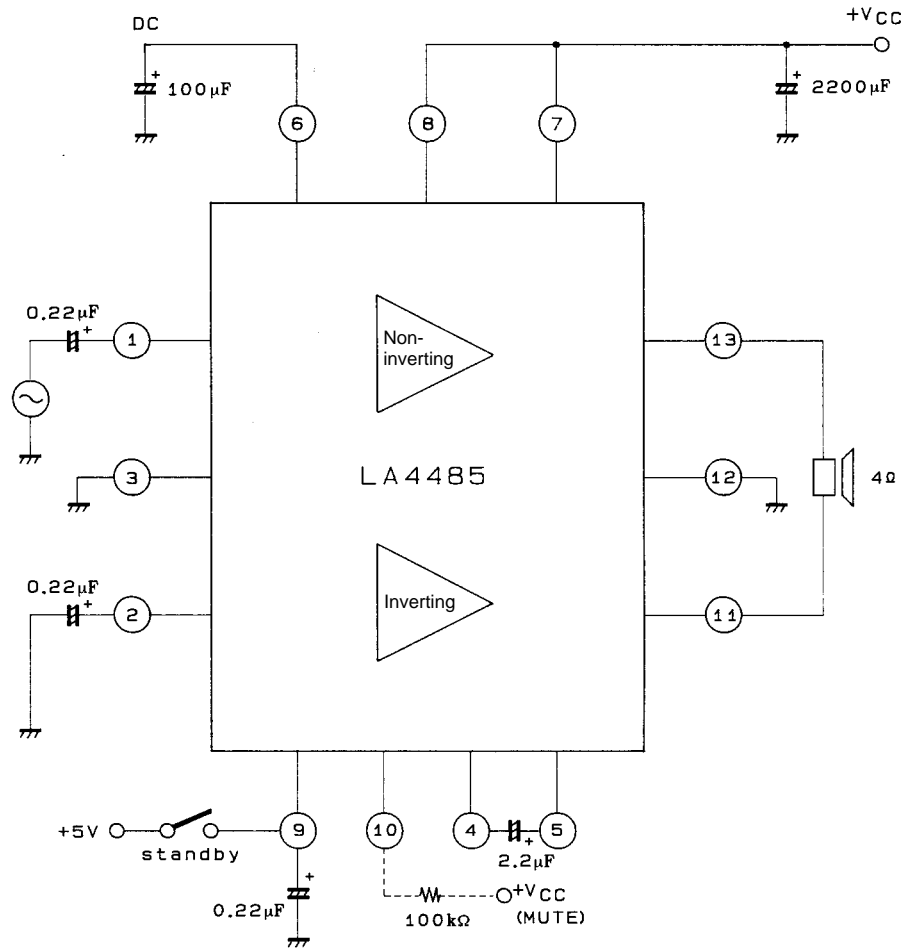
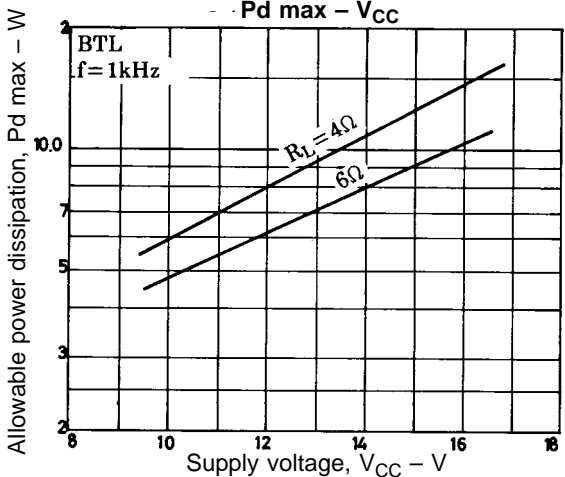
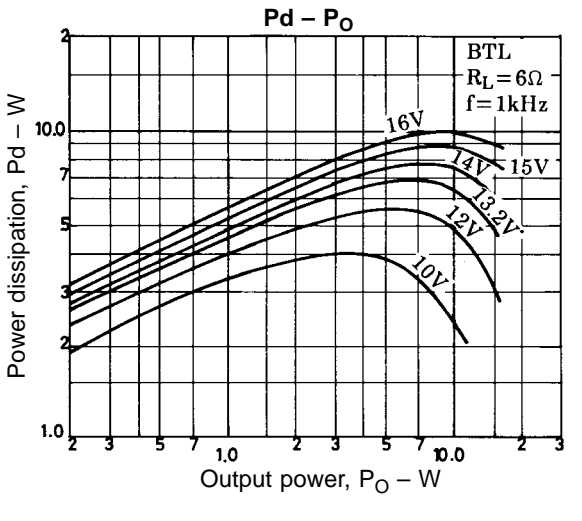
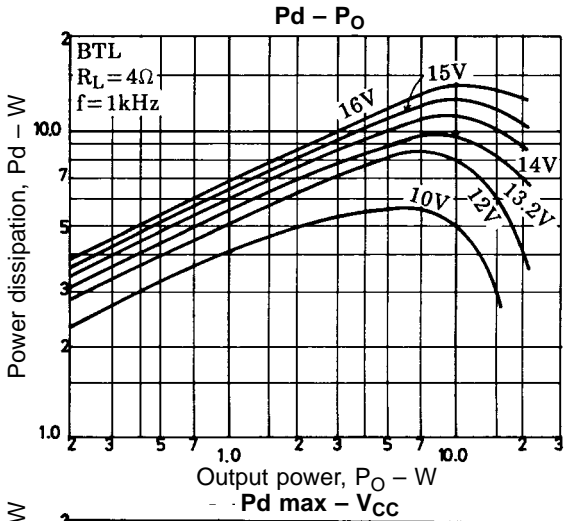
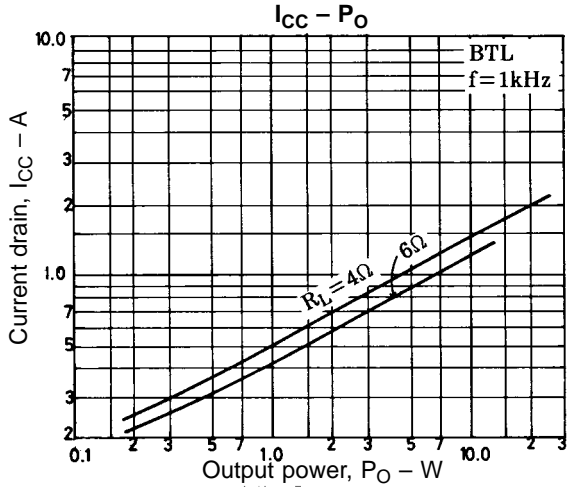
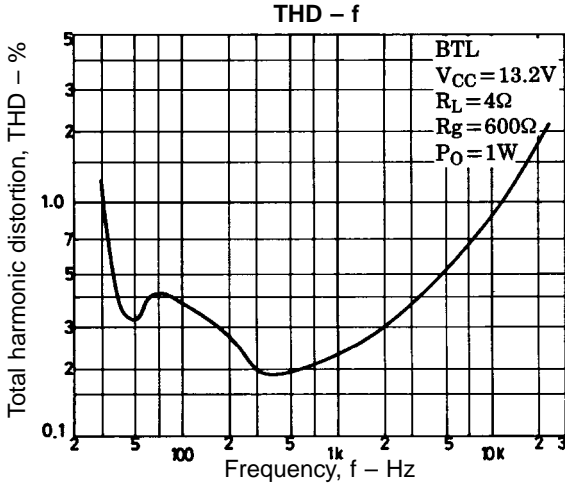
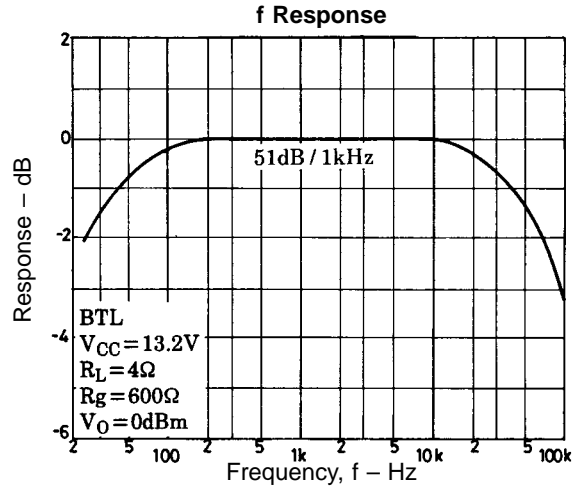
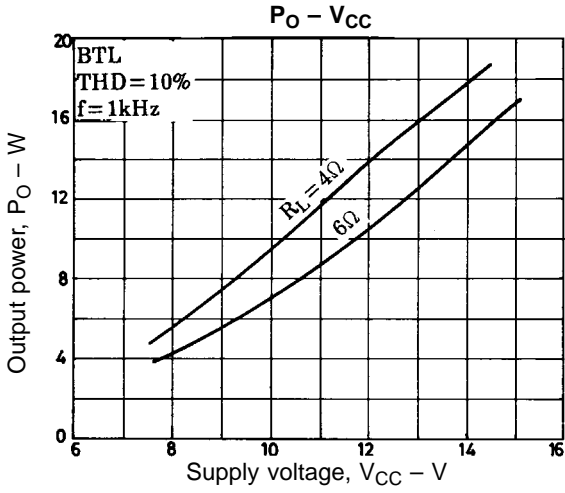

Figure 3

LA4485, BTL Sample Application Circuit





LA4485

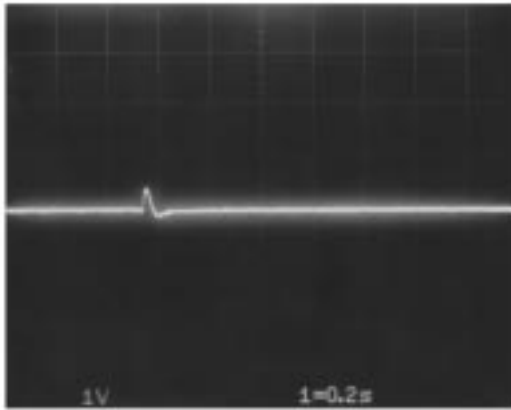

BTL

Speaker terminal

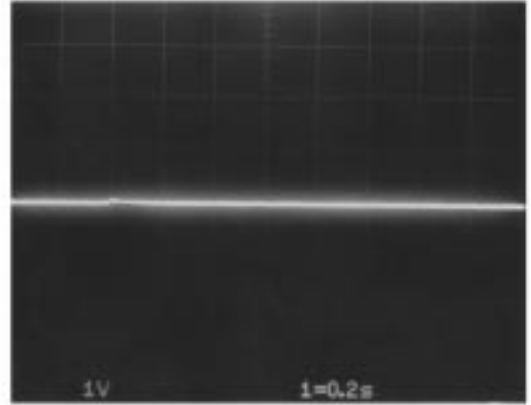

$V_{CC} = 13.2\text{ V}$, standby +5 V,
 $R_L = 4\ \Omega$, $R_g = 0$
 Main switch ON/OFF test

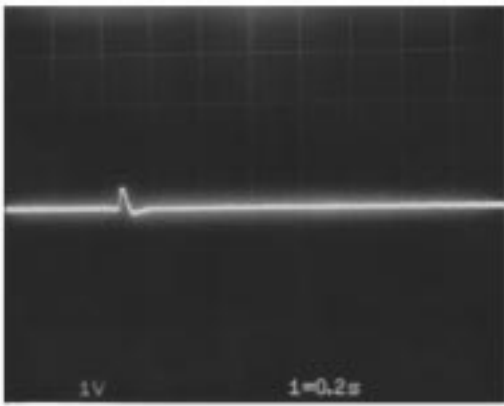

BTL

Speaker terminal

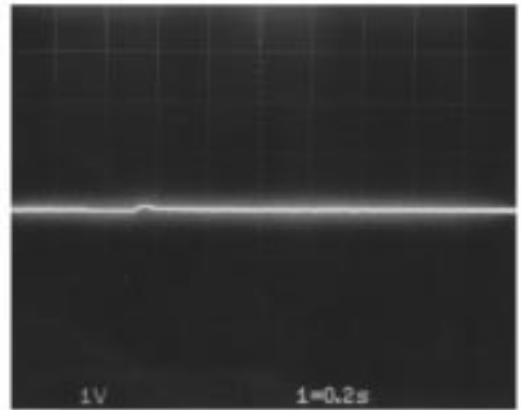

$V_{CC} = 13.2\text{ V}$, standby +5 V,
 $R_L = 4\ \Omega$, $R_g = 0$
 Standby switch ON/OFF test

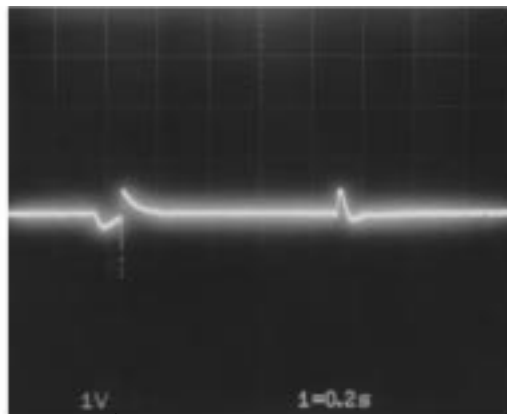
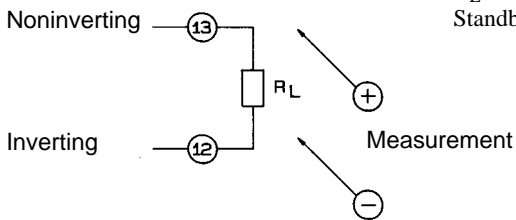

BTL

$V_{CC} = 13.2\text{ V}$
 $R_L = 4\ \Omega$
 $R_g = 0$
 Mute ON/OFF

Noninverting Inverting

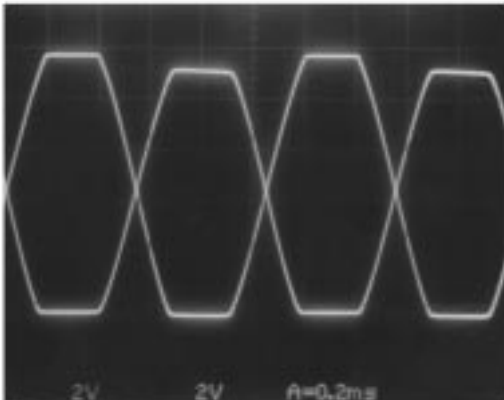

BTL

$V_{CC} = 13.2\text{ V}$,
 $R_L = 4\ \Omega$,
 $R_g = 600\ \Omega$,
 THD = 10%,
 $f = 1\text{ kHz}$
 Output DC waveform

Note: Switching noise decreases as $C_{IN} = 0.22\ \mu\text{F}$ (input) is increased. (ex. 2.2 μF)

BTL-mode Operation Notes

In BTL mode, channel 1 should be non-inverted and channel 2 should be inverted.

- Use the input capacitor C_{IN} in the range $0.22\ \mu\text{F}$ to $2.2\ \mu\text{F}$.
- Use the standby supply capacitor in the range $0.22\ \mu\text{F}$ to $1.0\ \mu\text{F}$.
When the capacitor is $2.2\ \mu\text{F}$ or more, the V_N trace for standby-off changes, and the switching noise increases significantly.
- The recommended DC (filter) capacitor is $100\ \mu\text{F}$ or greater.
- The BTL-mode coupling capacitor should be $2.2\ \mu\text{F}$.
When this capacitor is decreased, the output power is decreased. However, when this capacitor is increased, speaker turn-ON transient noise is increased significantly.
- In BTL mode, the ripple rejection ratio (SVRR) is approximately 40 dB.
This is because the output ripple portion of the noninverted side penetrates the BTL coupling end, so that ripple on the inverted side is large. The following method is described as one external measure:

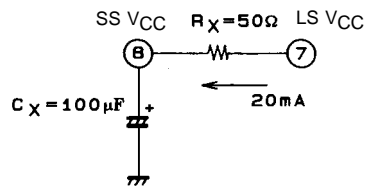

This measure yields an SVRR of approximately 50 dB. Note that the Rx loss voltage is approximately 1 V, and the P_O loss is about 1.0 to 1.5 W (to the 15 W level).

- Example of minimum parts for BTL operation

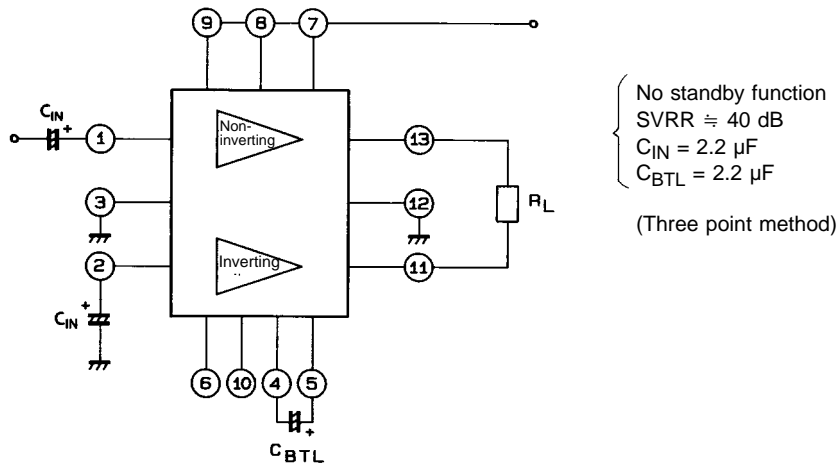

Dual-mode short-circuit test circuit

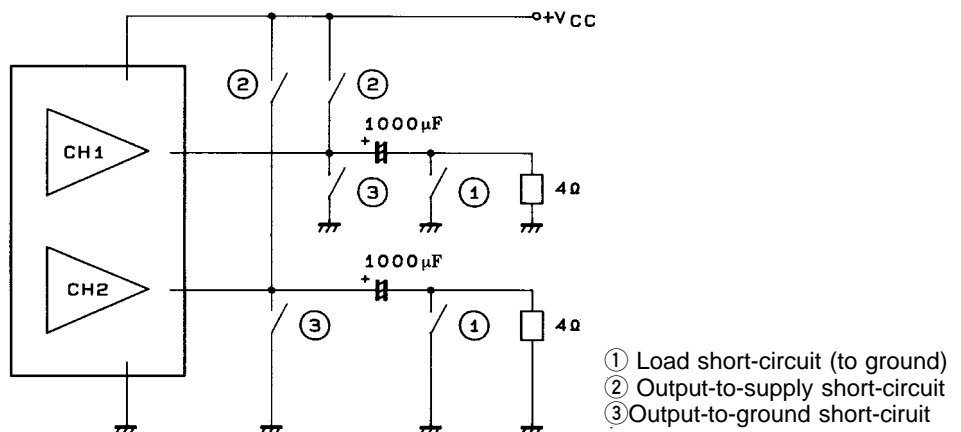

- Taking BTL coupling into consideration, the output-to-supply/output-to-ground protector is two-sided in order to protect both the IC and the speaker.

Short-circuit to GND protection

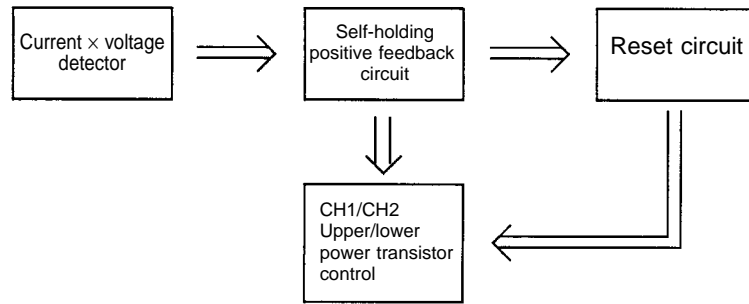

When using this method (simultaneously shorting the outputs to supply and to ground)

In BTL mode, the IC protection function works even in noninverted output → output-to-supply mode, inverted output → output-to-ground mode. (The reverse is also OK.)

Reference Value

- (a) Short-circuit test for dual-mode operation after the main and standby switches are turned ON.
 Conditions: ① $V_{CC} = 10$ to 16 V, $R_L = 4 \Omega$ and $P_O = 1$ to 5 W (variable) for load short-circuit
 ② $V_{CC} = 10$ to 16 V, $R_L = 4 \Omega$, $R_g = 0$ (no signal) for output-to-supply short-circuit
 ③ $V_{CC} = 10$ to 16 V, $R_L = 4 \Omega$, $R_g = 0$ (no signal) for output-to-ground short-circuit.

Z: impedance ○: no device breakdown

① Load short-circuit	② Output-to-supply short-circuit				③ Output-to-ground short-circuit			
	One-time test		Repeated switching test		One-time test		Repeated switching test	
	Z = 0	Z = 0.5 Ω	Z = 0	Z = 0.5 Ω	Z = 0	Z = 0.5 Ω	Z = 0	Z = 0.5 Ω
○	○	○	○	○	○	○	○	○

- (b) Short-circuit test for dual-mode operation (opposite flow of (a)) after the main and standby switches are turned ON.

Conditions: same as (a) ○: No device breakdown

① Load short-circuit	② Output-to-supply short-circuit				③ Output-to-ground short-circuit			
	One-time test		Repeated switching test		One-time test		Repeated switching test	
	Z = 0	Z = 0.5 Ω	Z = 0	Z = 0.5 Ω	Z = 0	Z = 0.5 Ω	Z = 0	Z = 0.5 Ω
○	○	○	○	○	○	○	○	○

(Note) Shorting the outputs to ground when muting is active can result in device breakdown.

- BTL-mode short-circuit test circuit

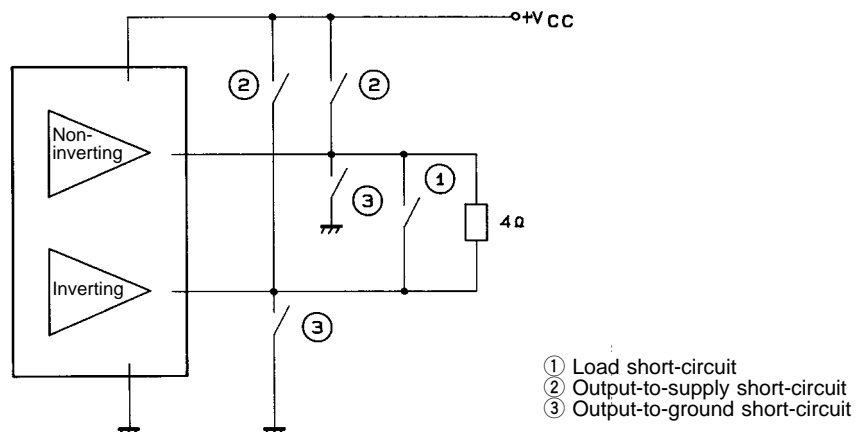

LA4485

Reference Value

- (a) Short-circuit test for BTL-mode operation after the main and standby switches are turned ON.
 Conditions: ① $V_{CC} = 10$ to 16 V, $R_L = 4 \Omega$ and $P_O = 1$ to 15 W (variable) for load short-circuit
 ② $V_{CC} = 10$ to 16 V, $R_L = 4 \Omega$, $R_g = 0$ (no signal) for output-to-supply short-circuit
 ③ $V_{CC} = 10$ to 16 V, $R_L = 4 \Omega$, $R_g = 0$ (no signal) for output-to-ground short-circuit.

Z: impedance ○: no device breakdown

① Load short-circuit	② Output-to-supply short-circuit				③ Output-to-ground short-circuit			
	One-time test		Repeated switching test		One-time test		Repeated switching test	
	Z = 0	Z = 0.5 Ω	Z = 0	Z = 0.5 Ω	Z = 0	Z = 0.5 Ω	Z = 0	Z = 0.5 Ω
○	○	○	○	○	○	○	○	○

- (b) Short-circuit test for BTL-mode operation (opposite flow of (a)) after the main and standby switches are turned ON.

Conditions: same as (a) ○: No device breakdown

① Load short-circuit	② Output-to-supply short-circuit				③ Output-to-ground short-circuit			
	One-time test		Repeated switching test		One-time test		Repeated switching test	
	Z = 0	Z = 0.5 Ω	Z = 0	Z = 0.5 Ω	Z = 0	Z = 0.5 Ω	Z = 0	Z = 0.5 Ω
○	○	○	○	○	○	○	○	○

(Note) Shorting the outputs to ground when muting is active can result in device breakdown.

- Power supply positive surge

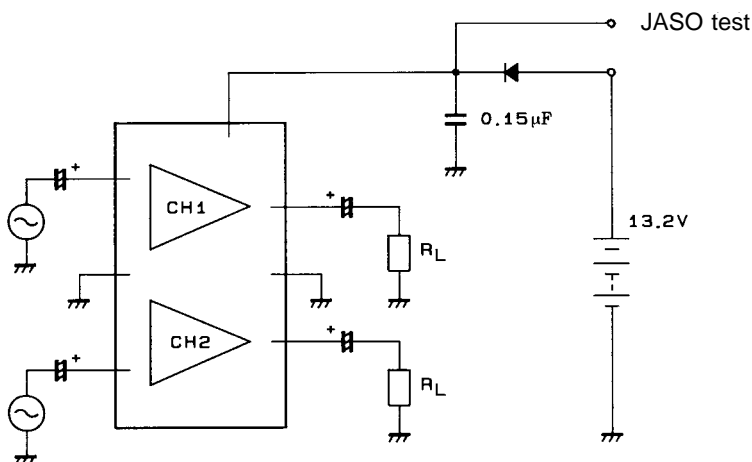

The power supply line positive surge breakdown margin has been increased by using the built-in overvoltage protection circuits ($V_{CCX} = 28$ V) to cut off all bias circuits/change the base-emitter reverse of the output stage. In other words, the breakdown margin is being raised by changing output stage groups that operate as the V_{CEO} (V_{CER}) type to the V_{CES} (V_{CBO}) type.

LA4485

- Test of application of $+V_{CC}$ to output pins

If the power supply pin is floating under the power supply capacitor insertion conditions, and $+V_{CC}$ comes into contact with output lines (a) and (b) as shown in the diagram above, the IC's internal upper power transistor will generally be damaged. The LA4485 has a protective bypass circuit on chip. However, it is dangerous if the power supply capacitor is greater than $2200\ \mu\text{F}$.

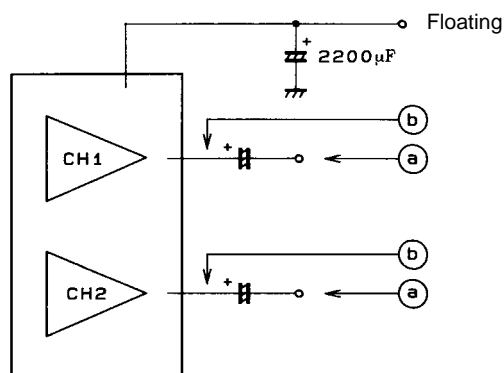

- No products described or contained herein are intended for use in surgical implants, life-support systems, aerospace equipment, nuclear power control systems, vehicles, disaster/crime-prevention equipment and the like, the failure of which may directly or indirectly cause injury, death or property loss.
- Anyone purchasing any products described or contained herein for an above-mentioned use shall:
 - ① Accept full responsibility and indemnify and defend SANYO ELECTRIC CO., LTD., its affiliates, subsidiaries and distributors and all their officers and employees, jointly and severally, against any and all claims and litigation and all damages, cost and expenses associated with such use:
 - ② Not impose any responsibility for any fault or negligence which may be cited in any such claim or litigation on SANYO ELECTRIC CO., LTD., its affiliates, subsidiaries and distributors or any of their officers and employees jointly or severally.
- Information (including circuit diagrams and circuit parameters) herein is for example only; it is not guaranteed for volume production. SANYO believes information herein is accurate and reliable, but no guarantees are made or implied regarding its use or any infringements of intellectual property rights or other rights of third parties.

This catalog provides information as of July, 1996. Specifications and information herein are subject to change without notice.